



**Comune di Montesilvano**

# PIANO URBANO DELLA MOBILITA' CICLABILE

## BICIANPLAN

### SEZIONI

Data: Marzo 2019

Scala: 1:50

**Progetto:**

**Arch. Alessandro Tursi**

Via Dalmazia 15

Giulianova (TE)

Collaboratore:

Genny Gallinelli

#### ELENCO SEZIONI STRADALI:

- Via D'Andrea
- Via Mantova Est
- Via Mantova Ovest
- Via Emilia
- Via Guidonia
- Via Lucania
- Via Metauro Ovest
- Via Adda Est
- Via Abruzzo Ovest
- Via Strasburgo Ovest
- Via Vestina  
(da SS 16 a Via Di Vittorio  $\geq 11$  m)
- Via Vestina  
(da SS 16 a Via Di Vittorio 9 - 10,5 m)
- Via Vestina  
(da Via Di Vittorio a confine comunale  $\geq 11$  m)
- Via Vestina  
(da Via Di Vittorio a confine comunale 9 - 10,5 m)
- Via Europa
- Via Sangro
- Via L'Aquila
- Via Marinelli
- SS16  
(da fiume Saline a Via Moro)
- SS16  
(da via Moro a Via Adige)
- Via Di Vittorio
- Via Cavallotti
- Via Piceni
- Via Nillo
- Via Egitto
- Via Fosso Foreste
- Via Senna Est
- Via Senna Ovest
- Via Barbato
- Via S. Gottardo

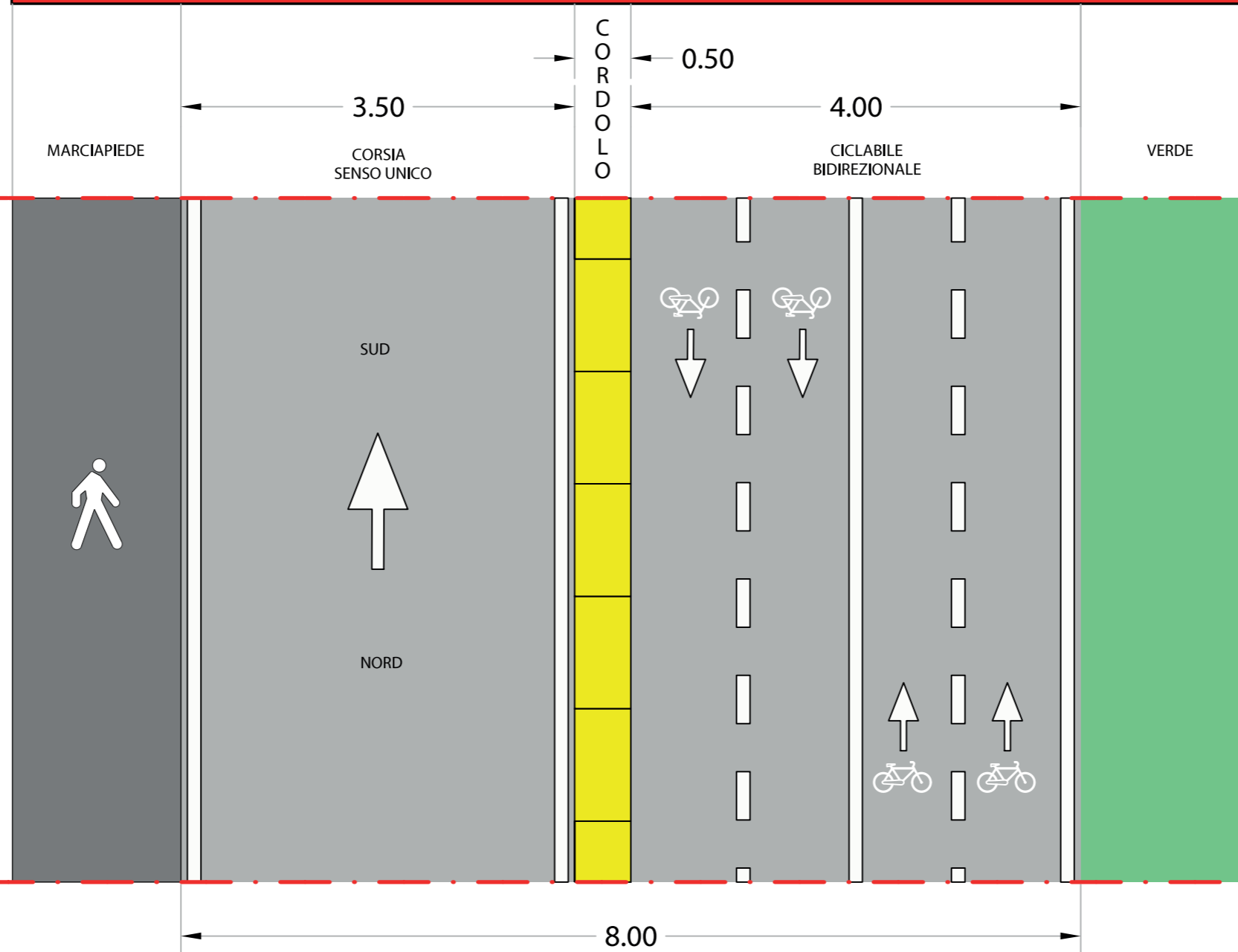
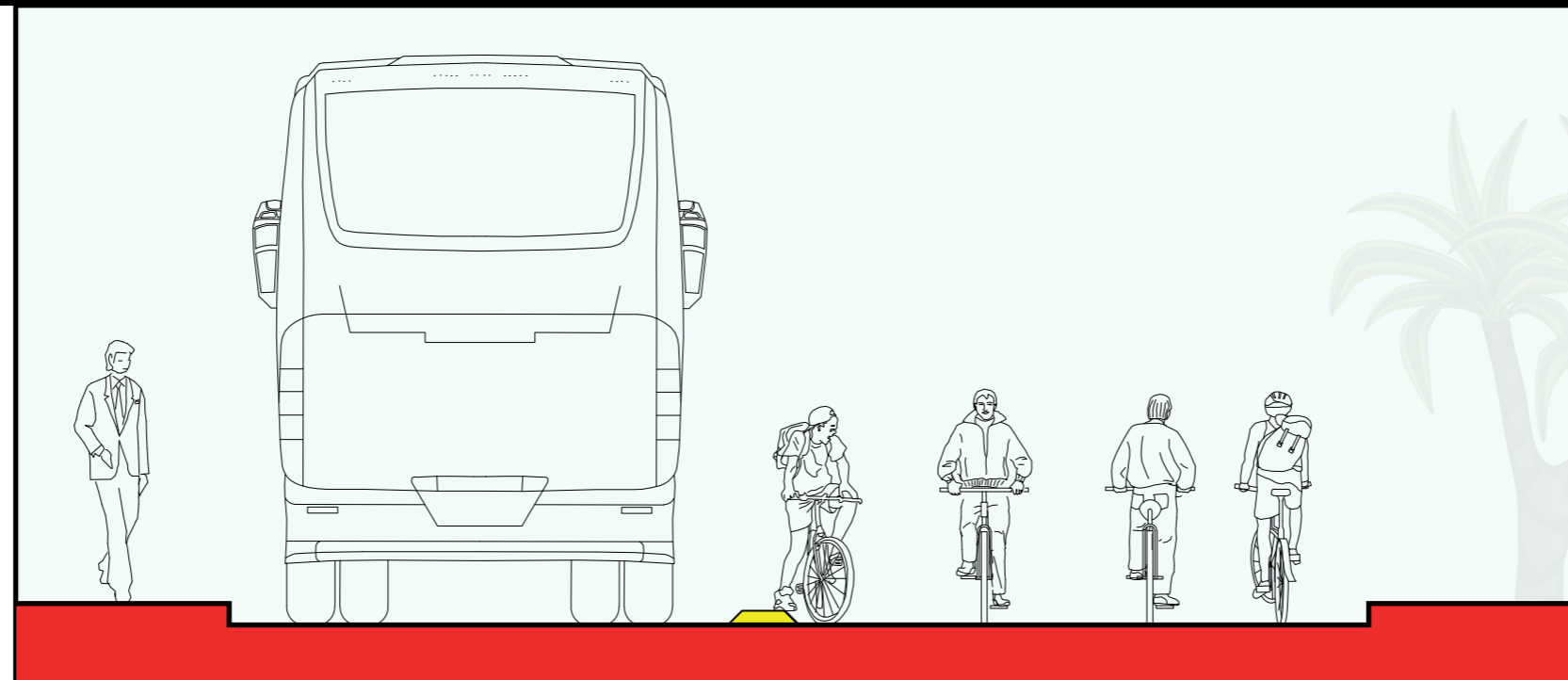

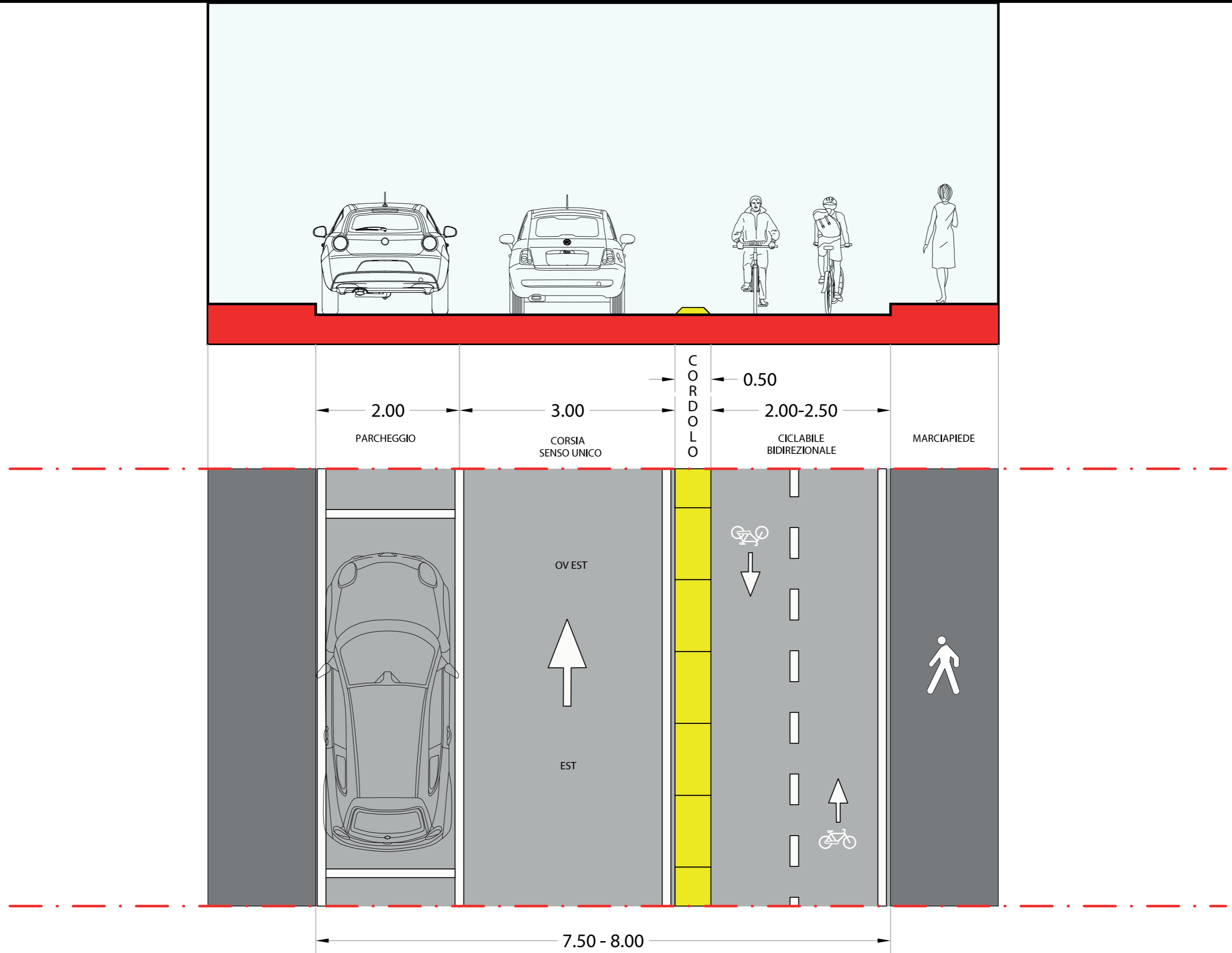

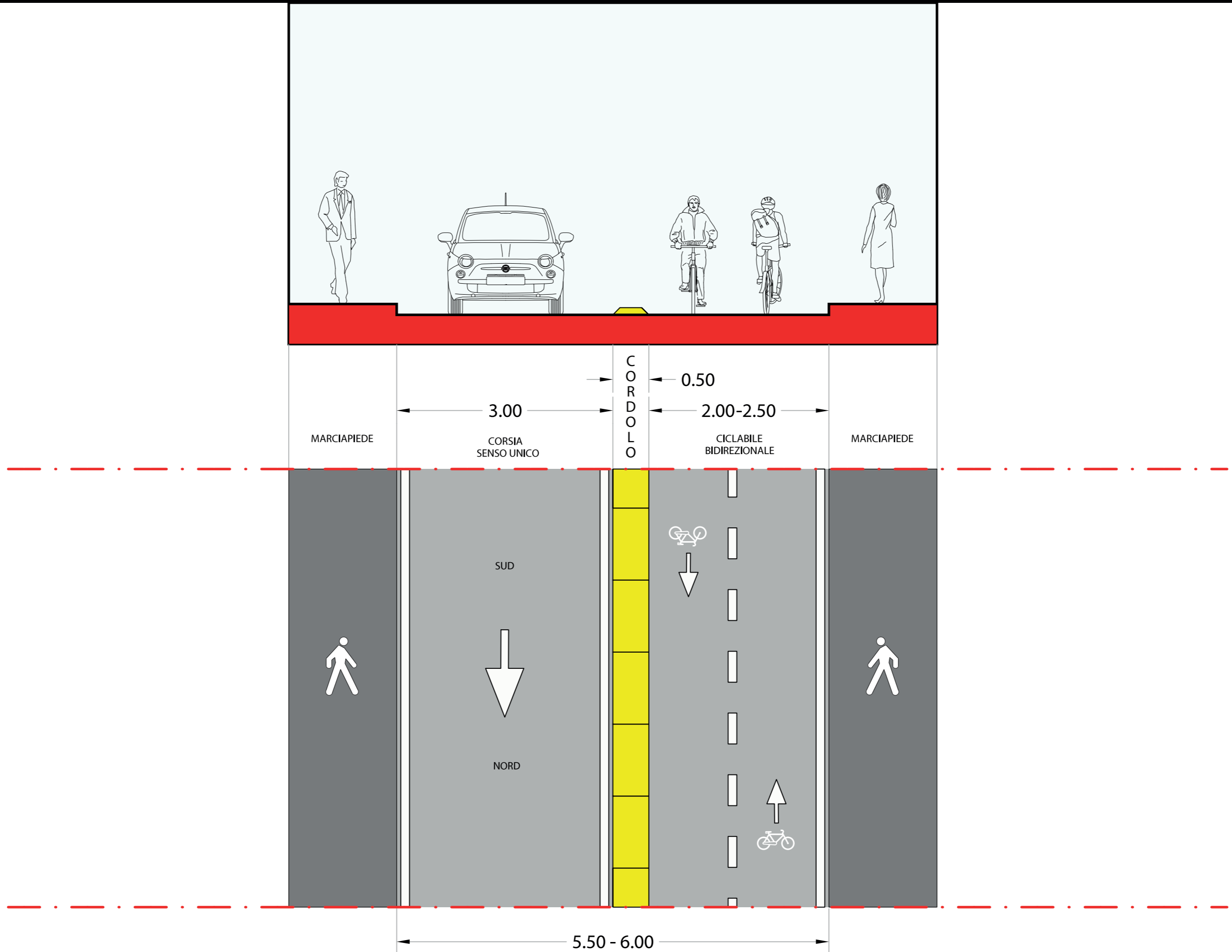

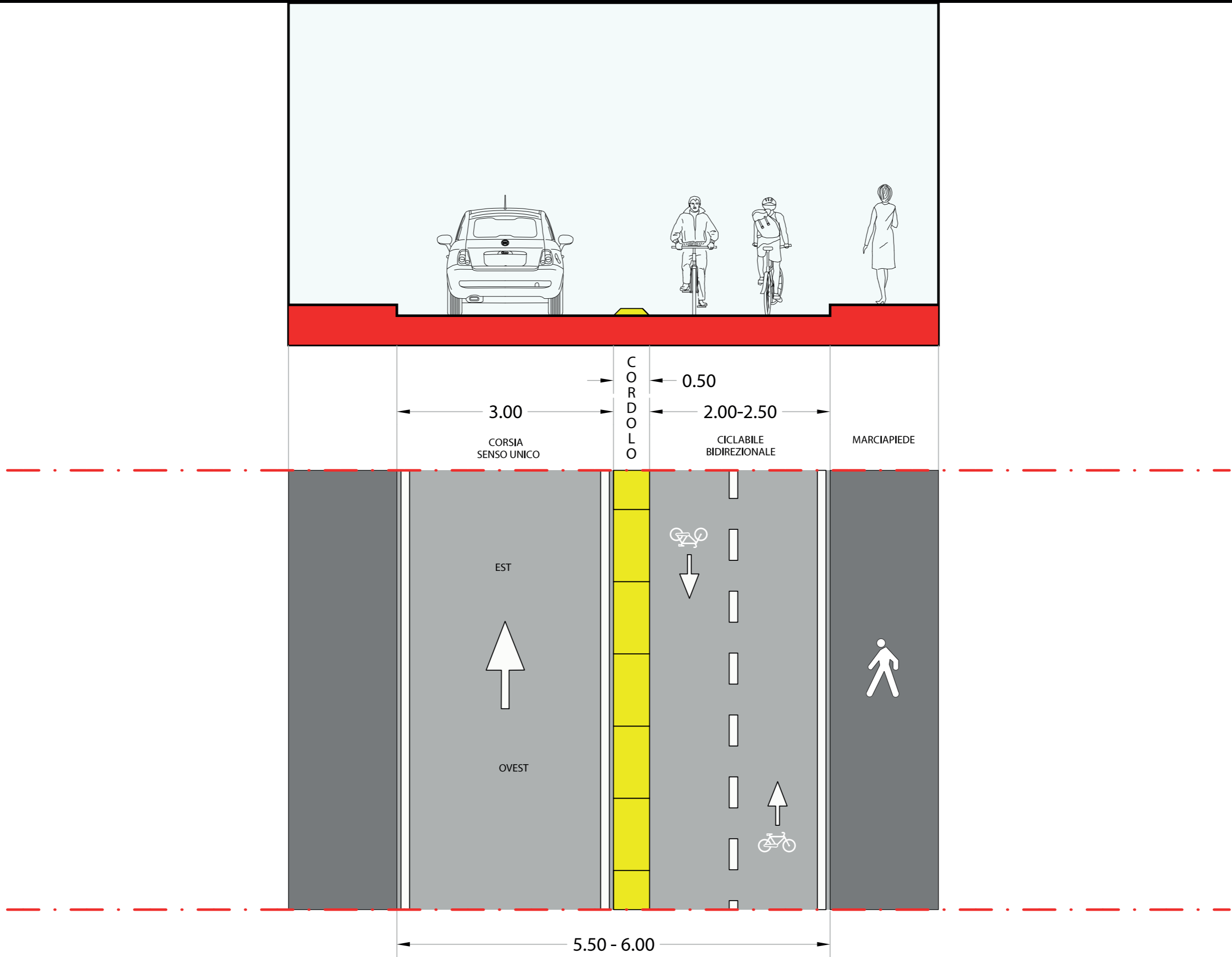

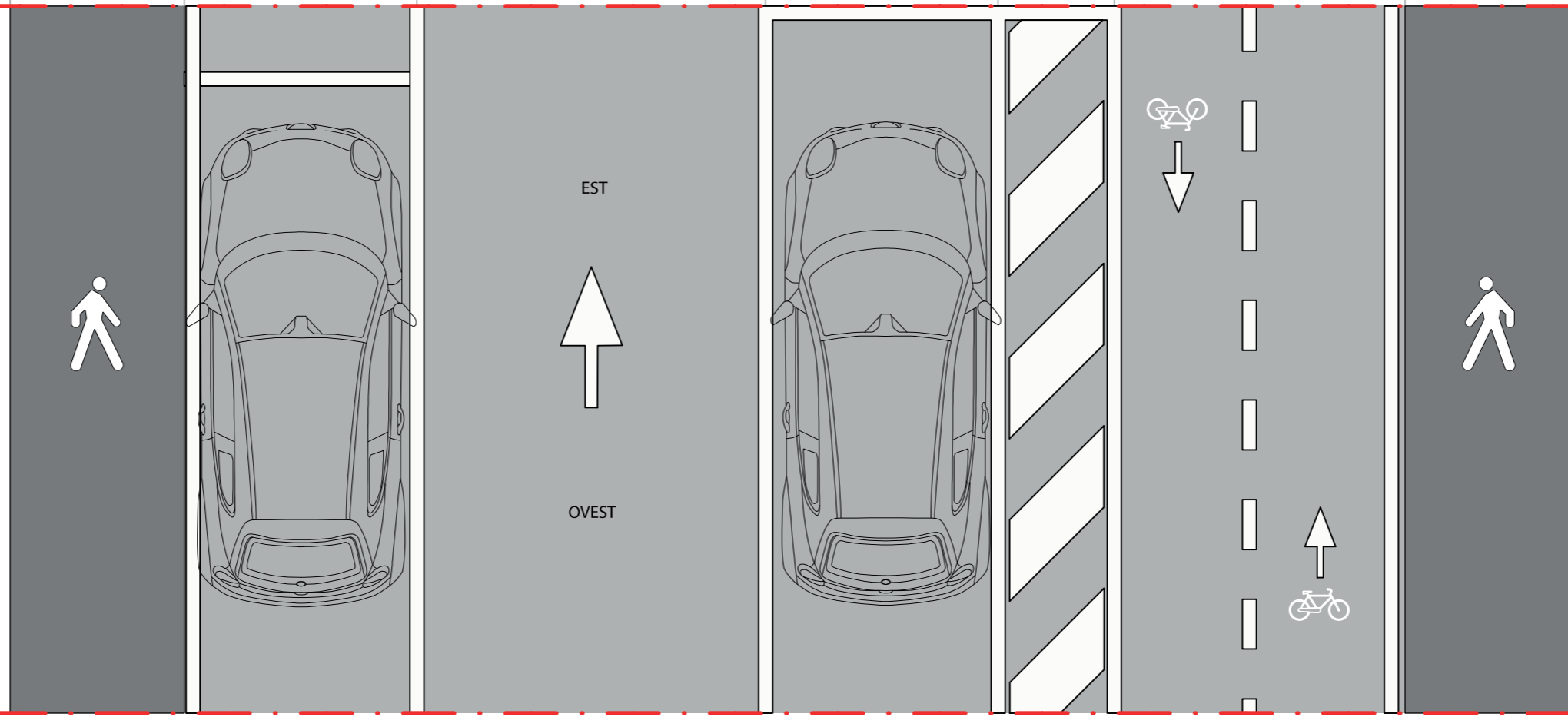
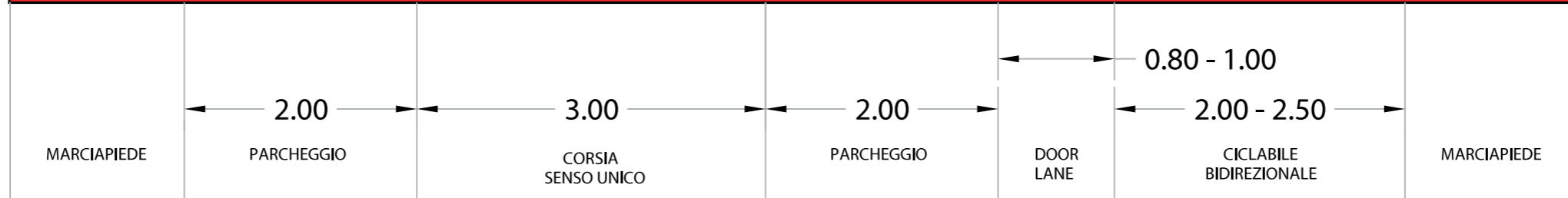
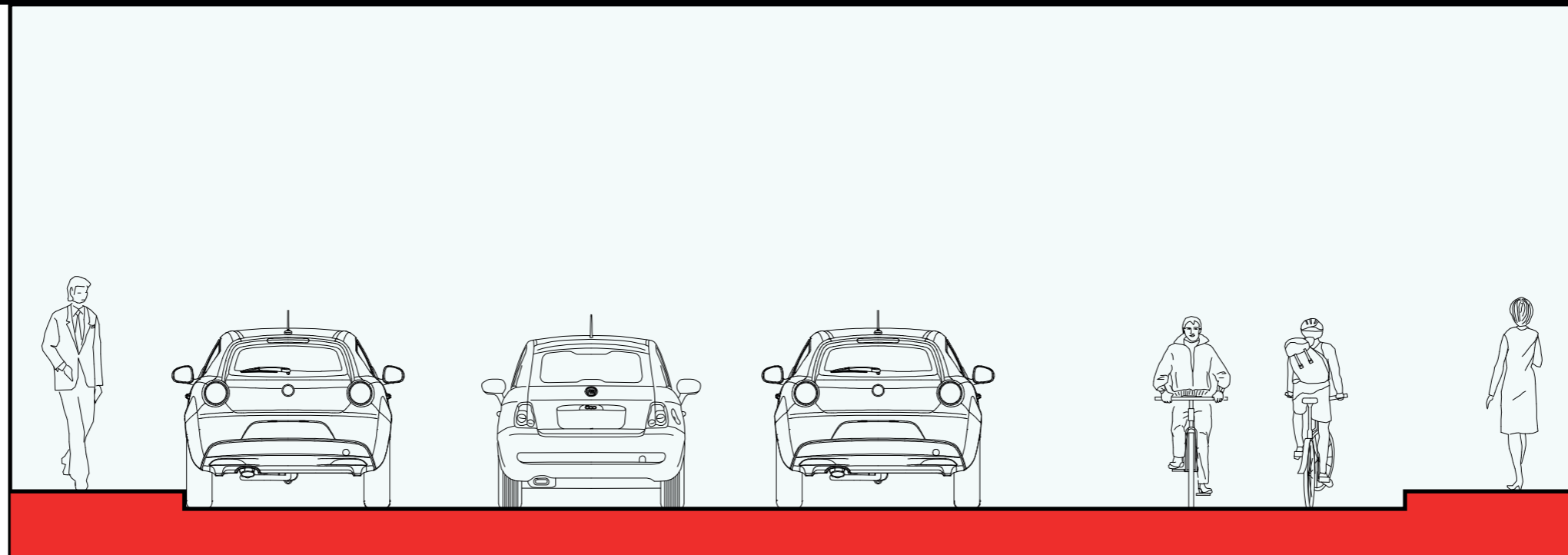

9.80 - 10.50

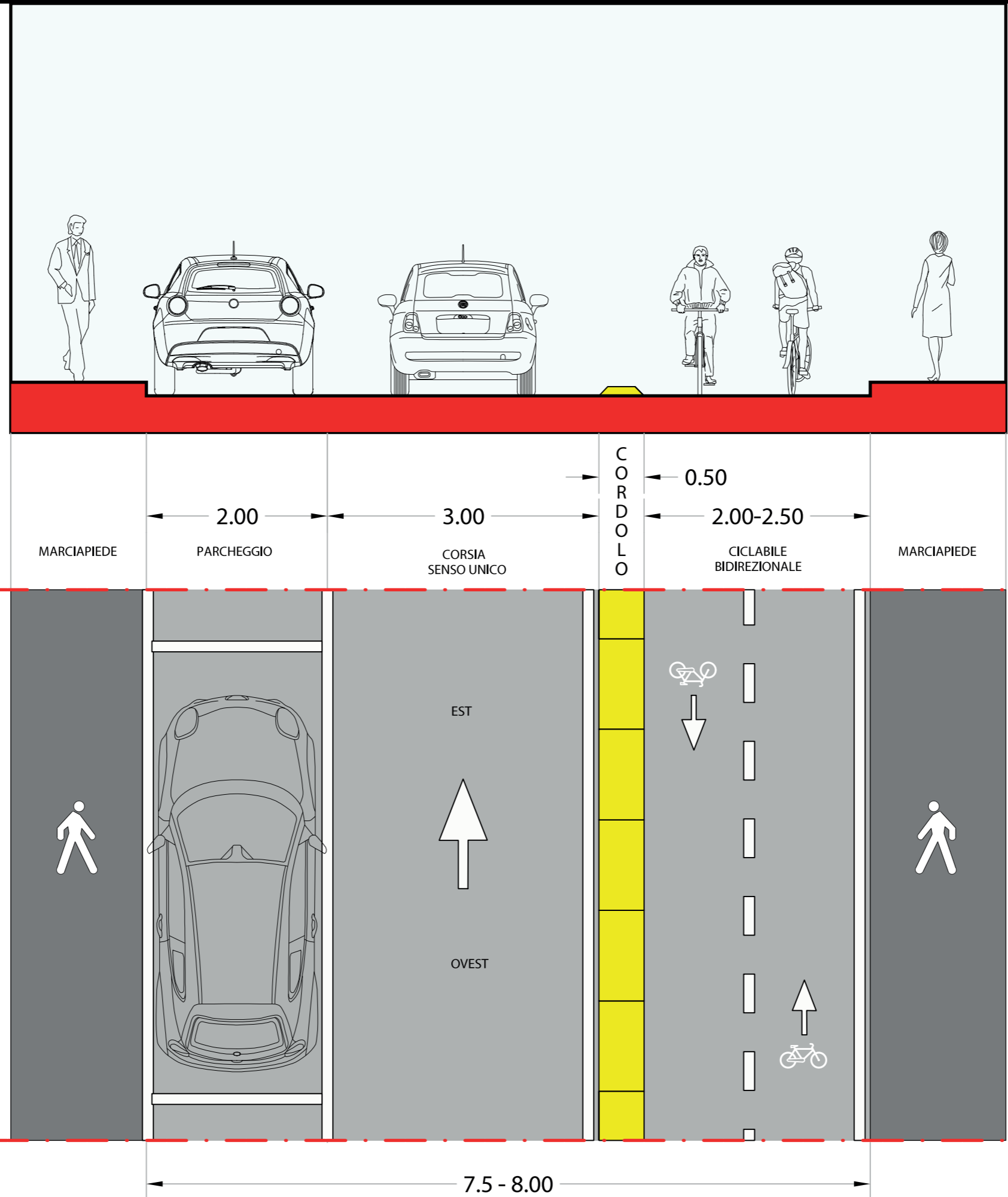

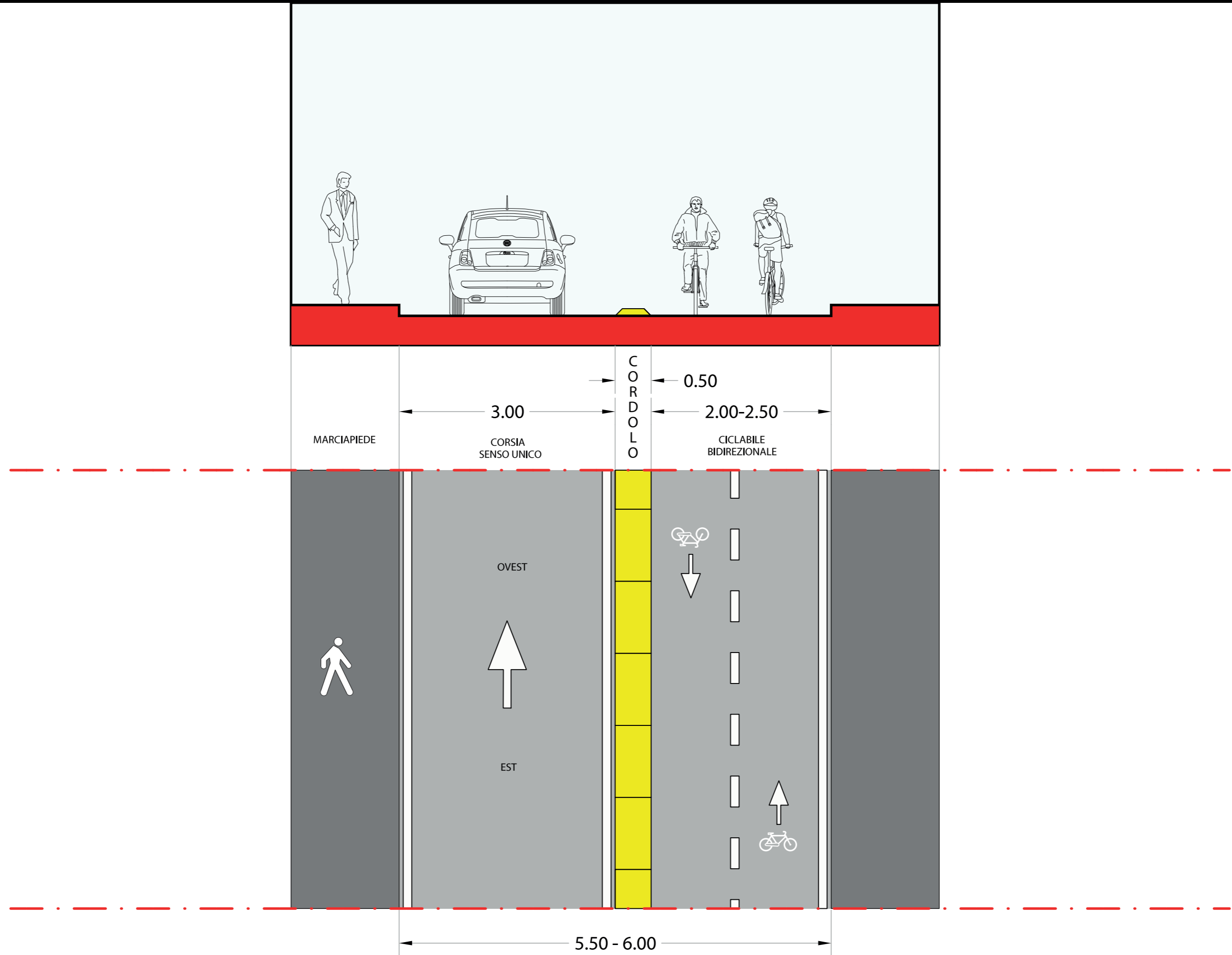



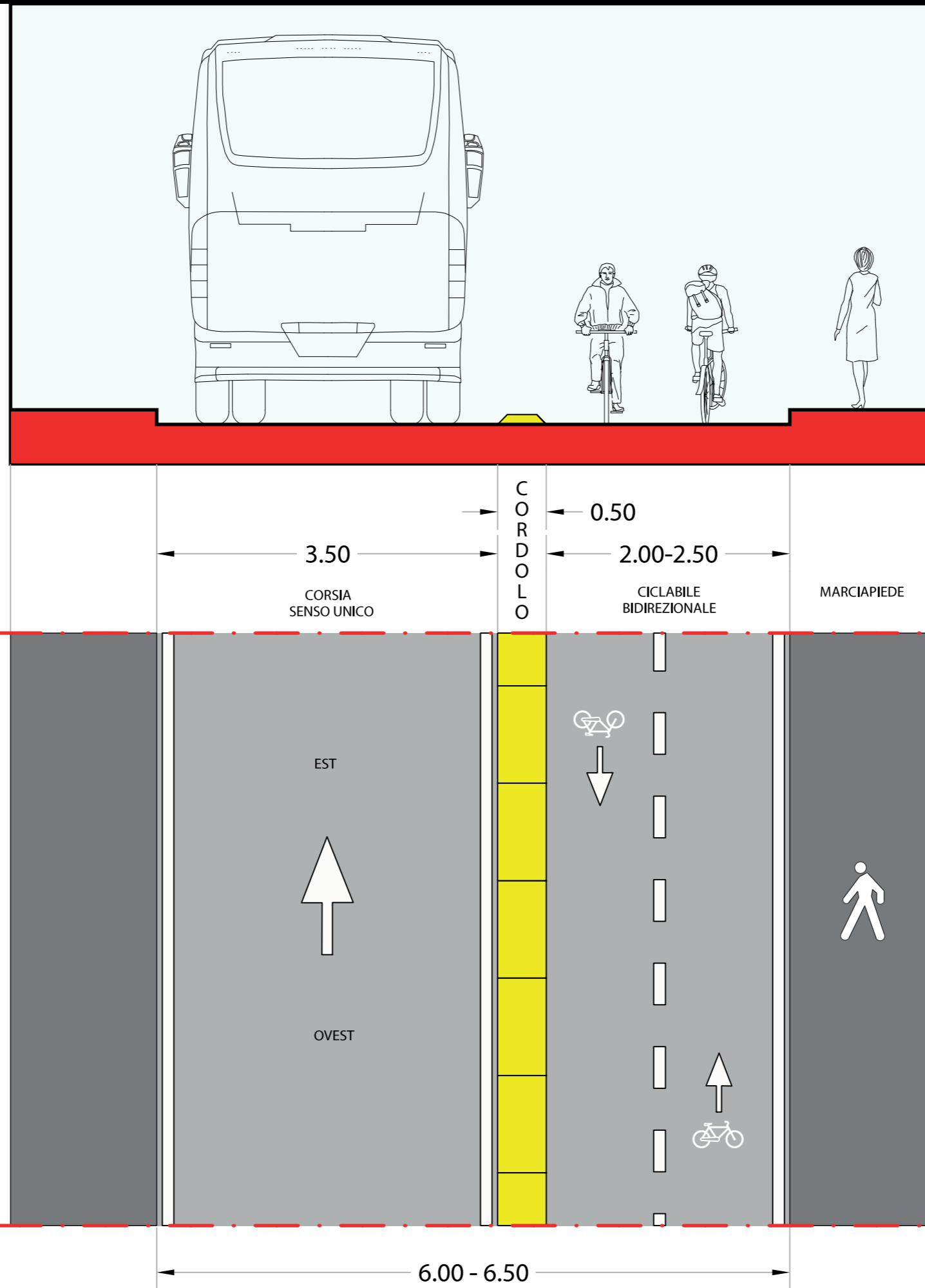

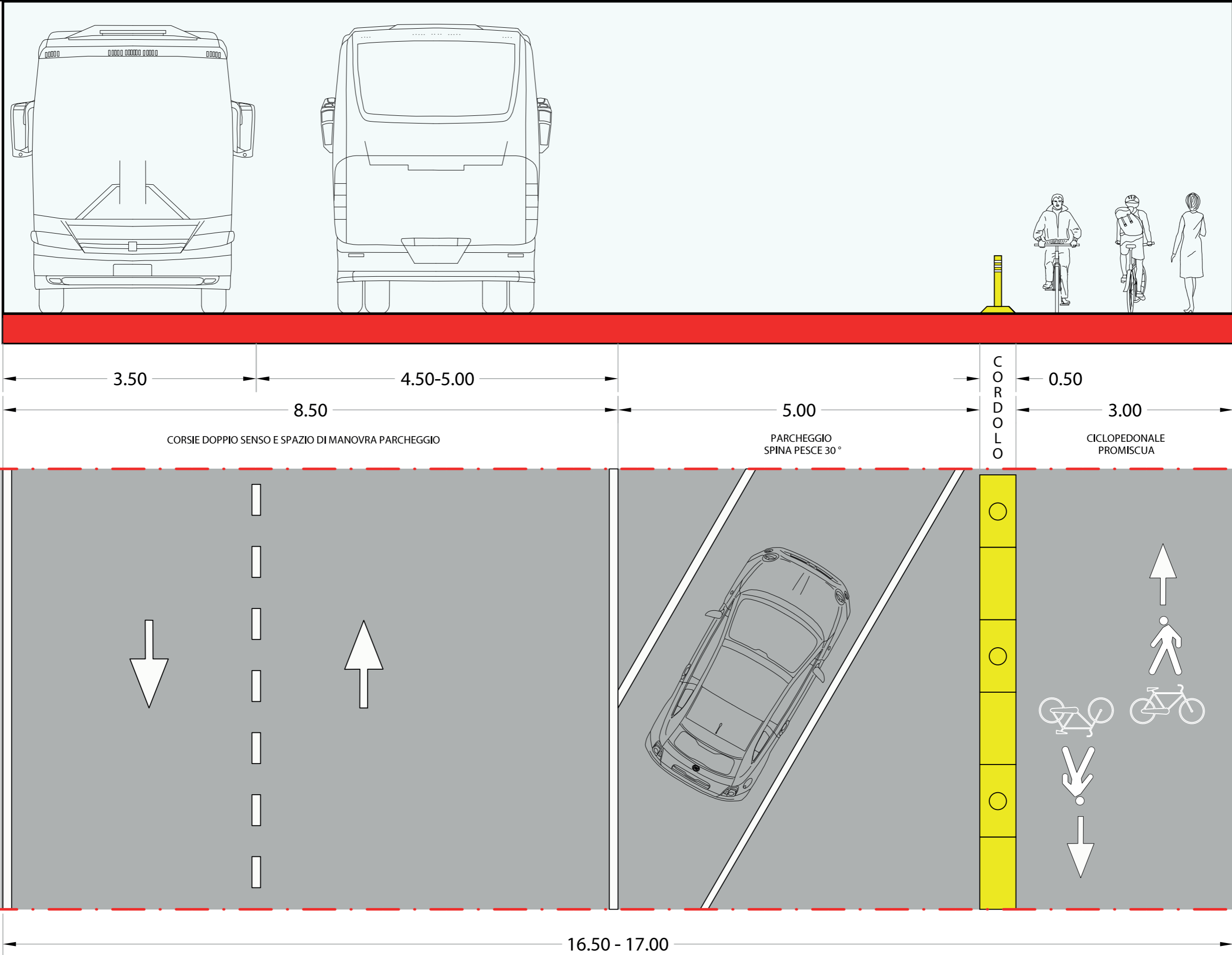

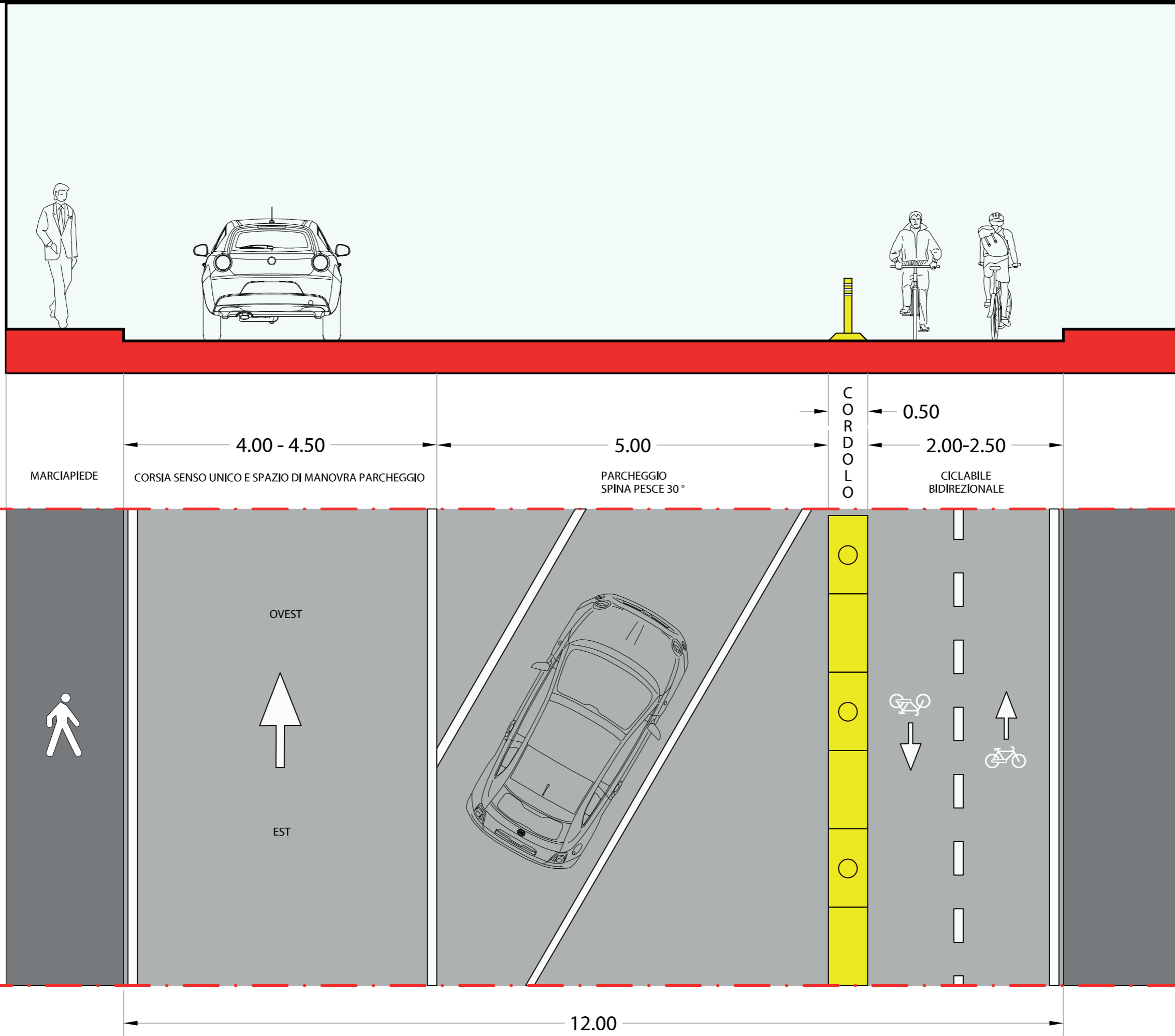

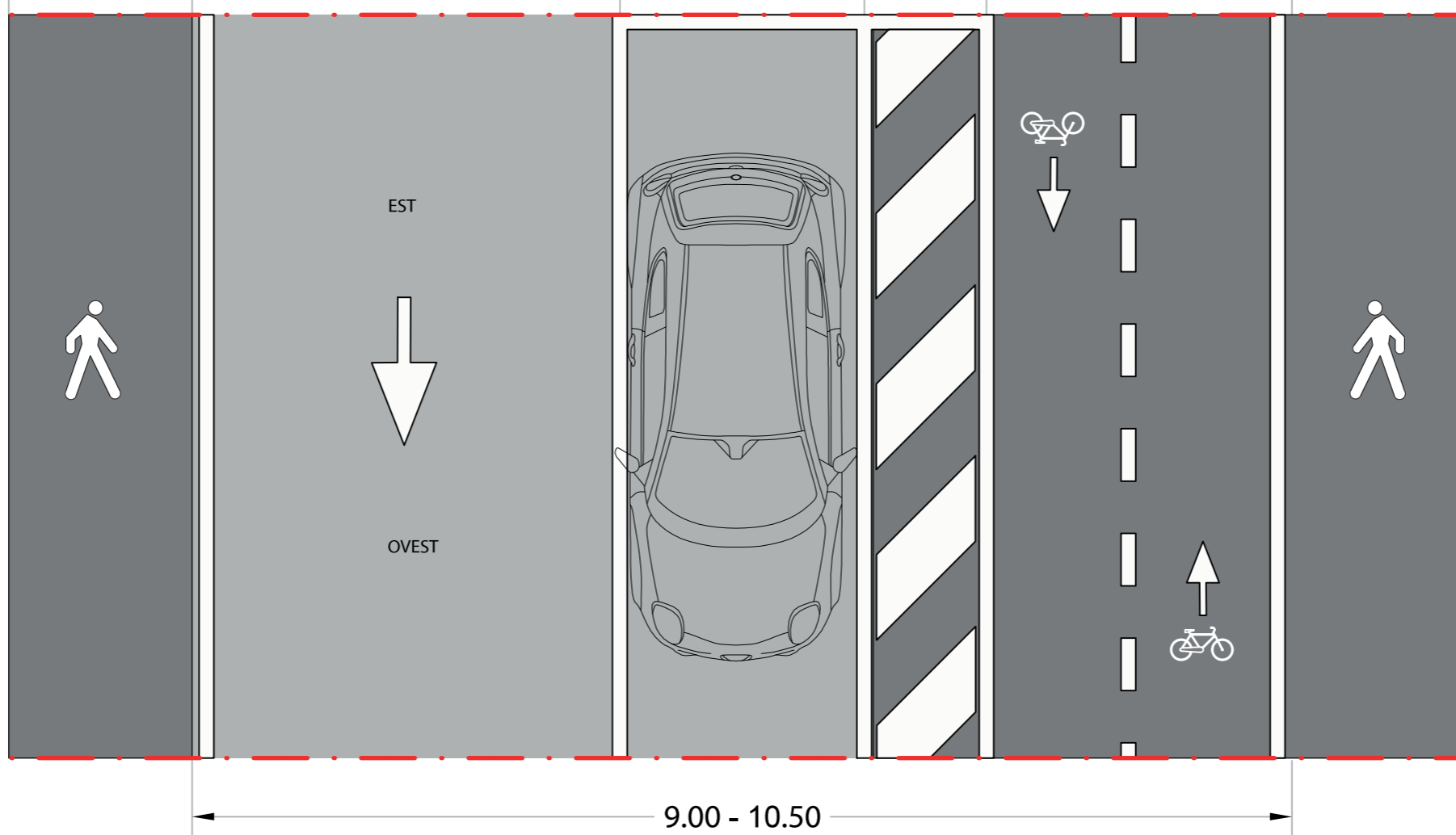
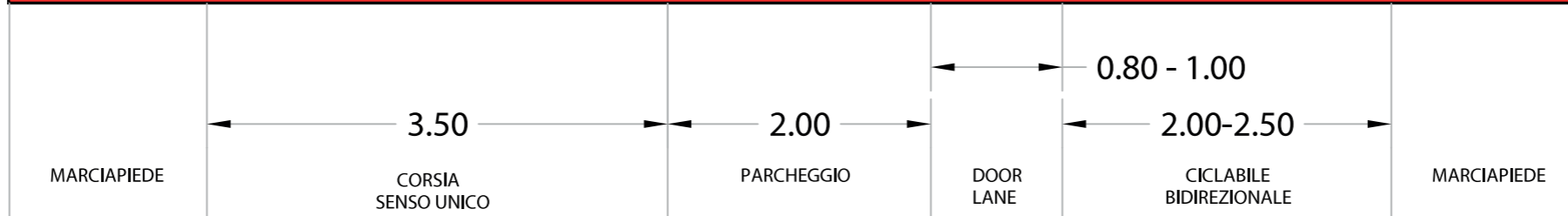
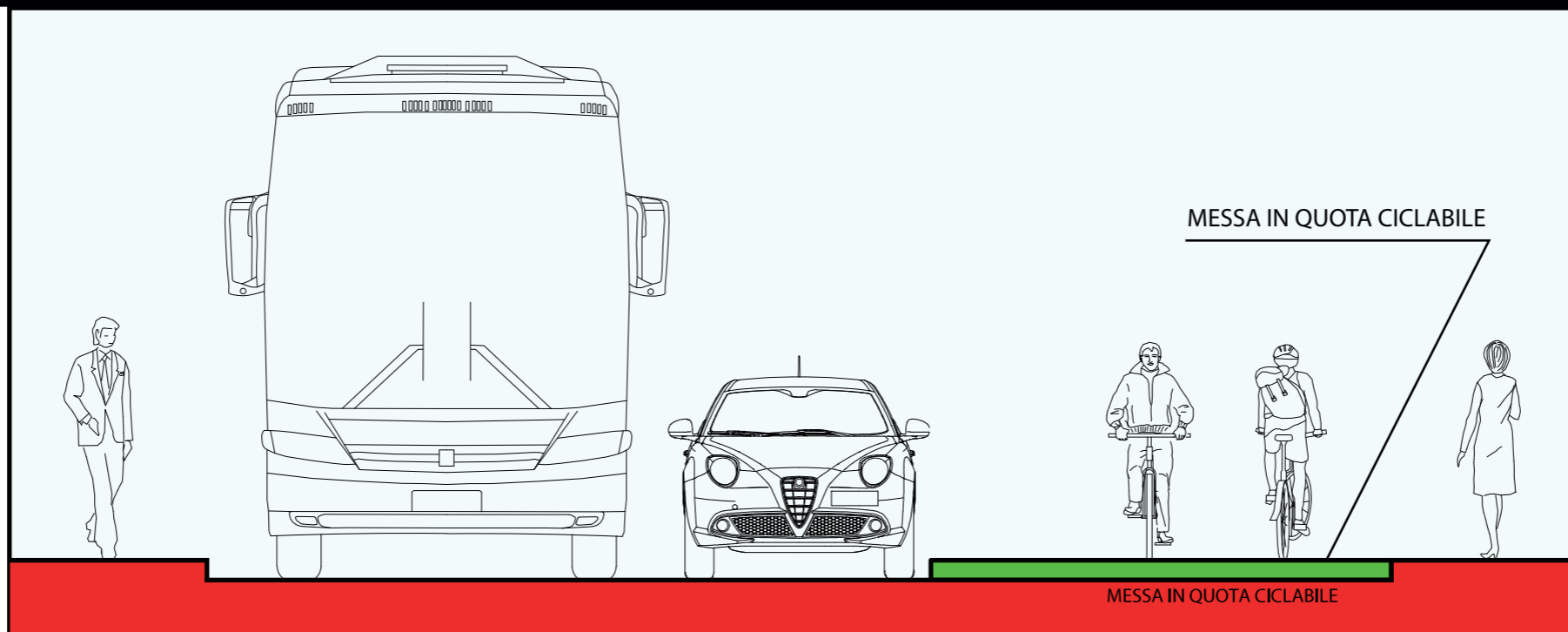

9.00 - 10.50

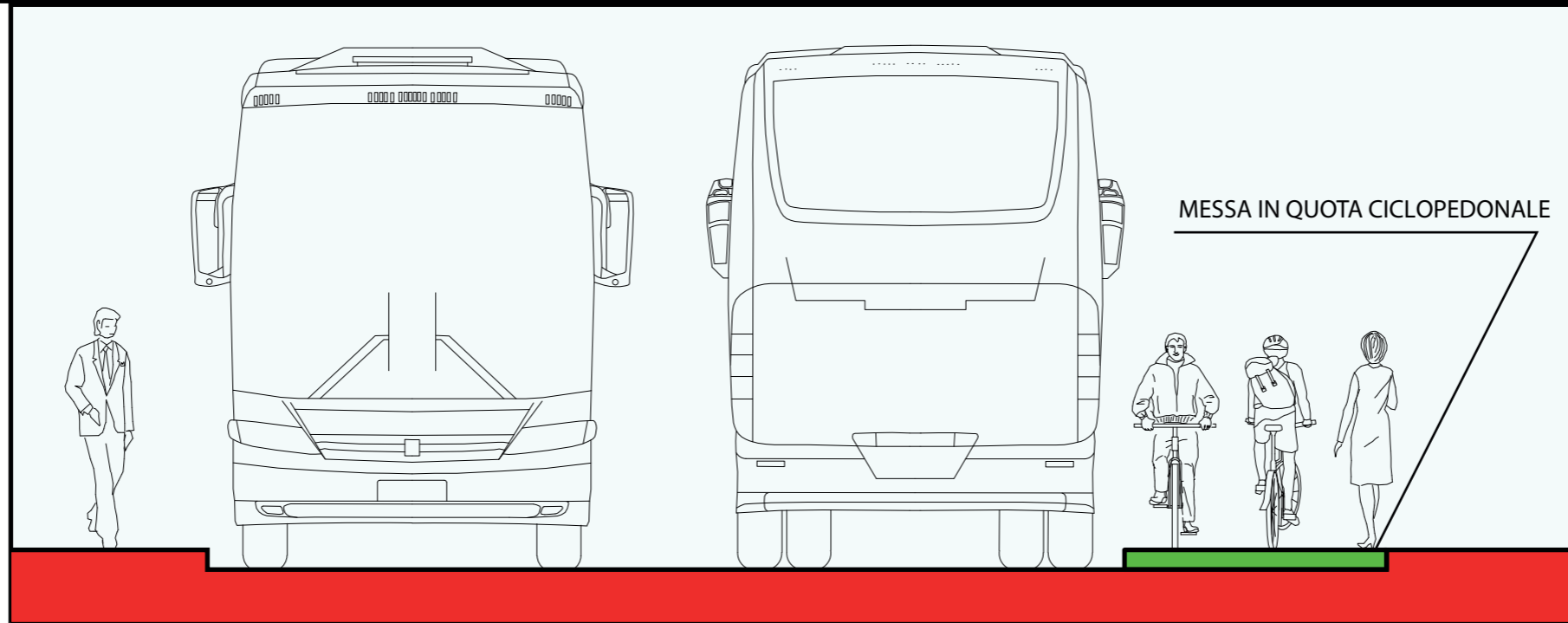

MARCIPIEDE      7.00      2.00 - 3.00      VAR.      MARCIPIEDE  
CORSIE DOPPIO SENSO      CICLOPEDONALE PROMISCUA

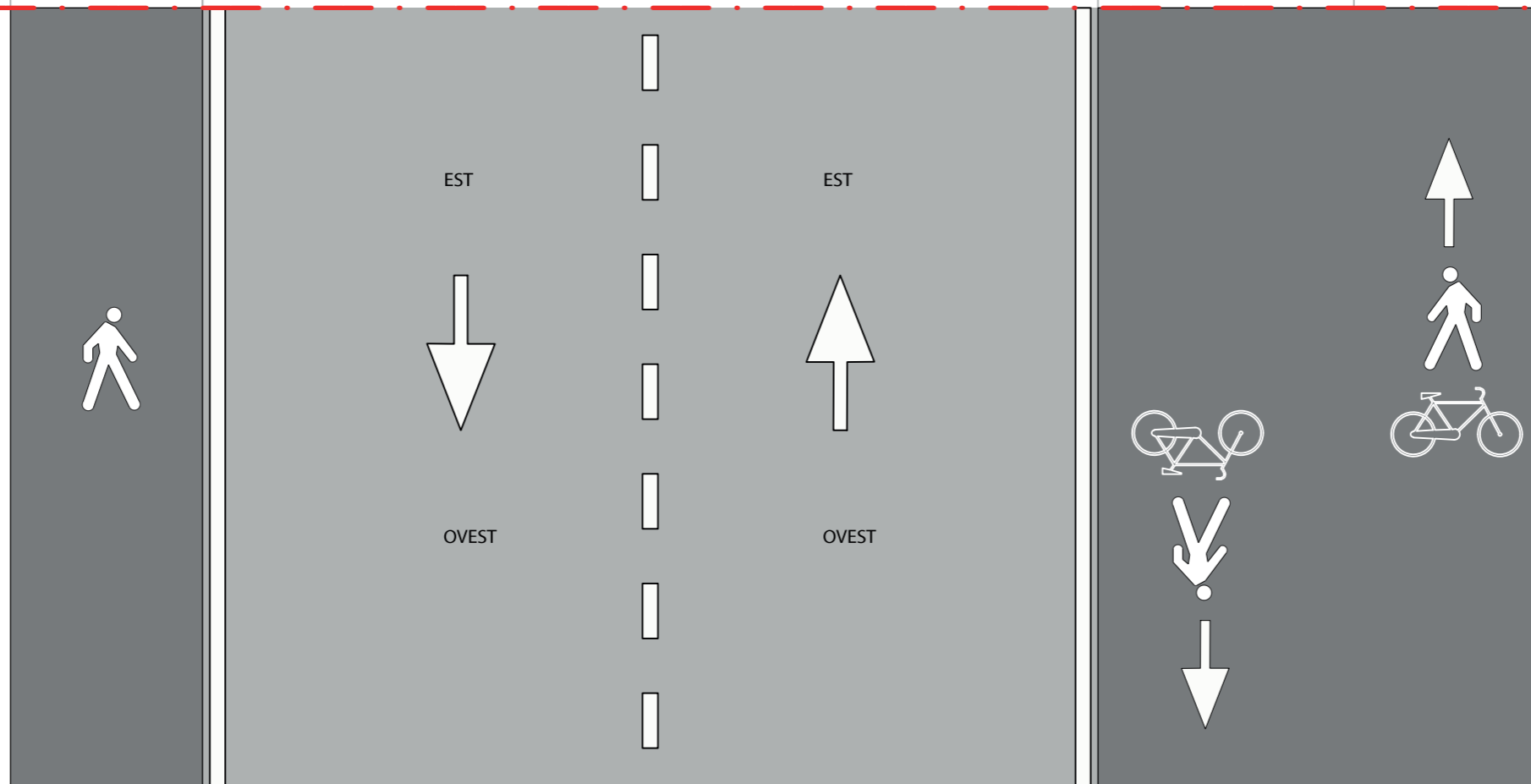

9.00 - 10.50

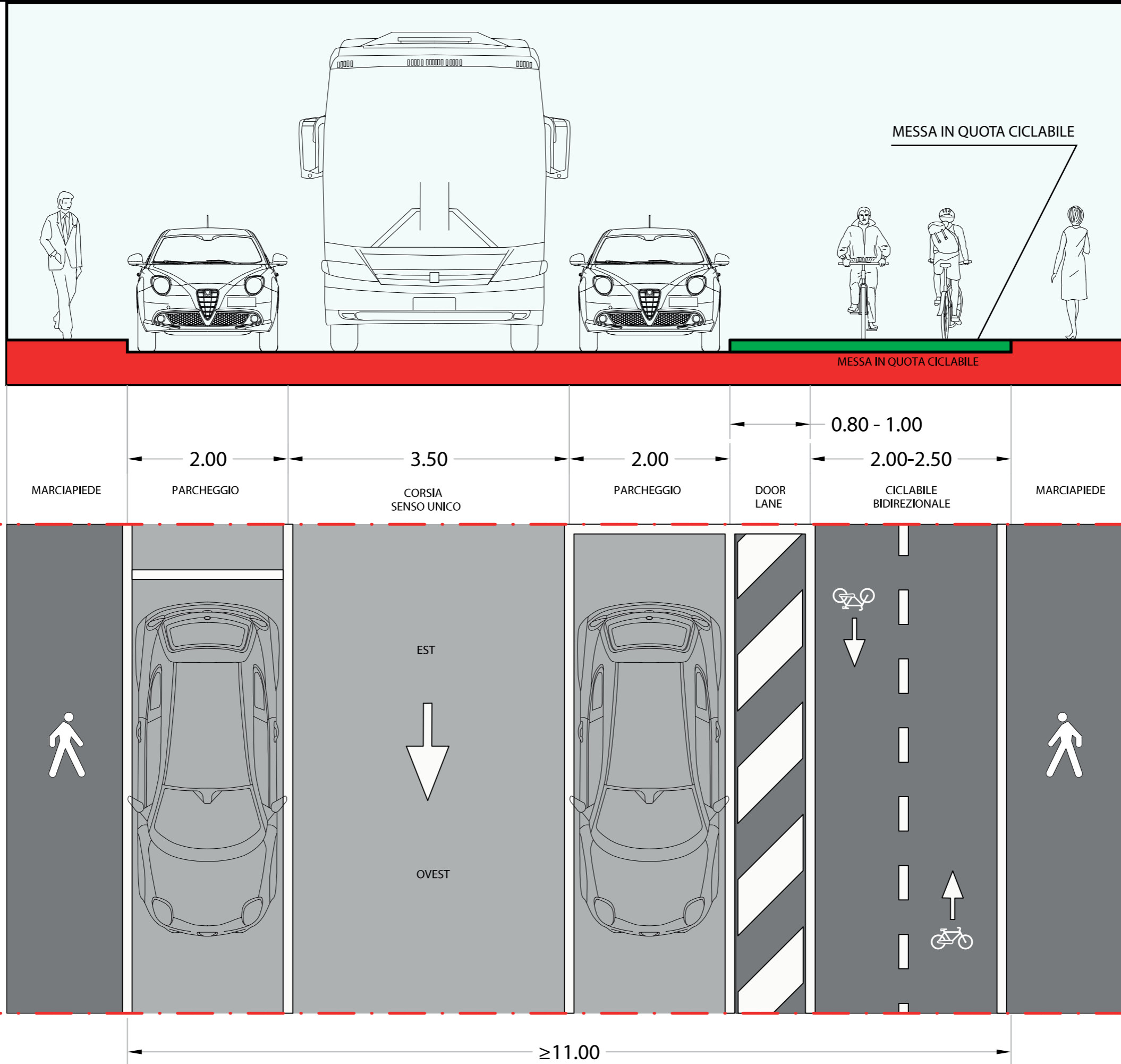

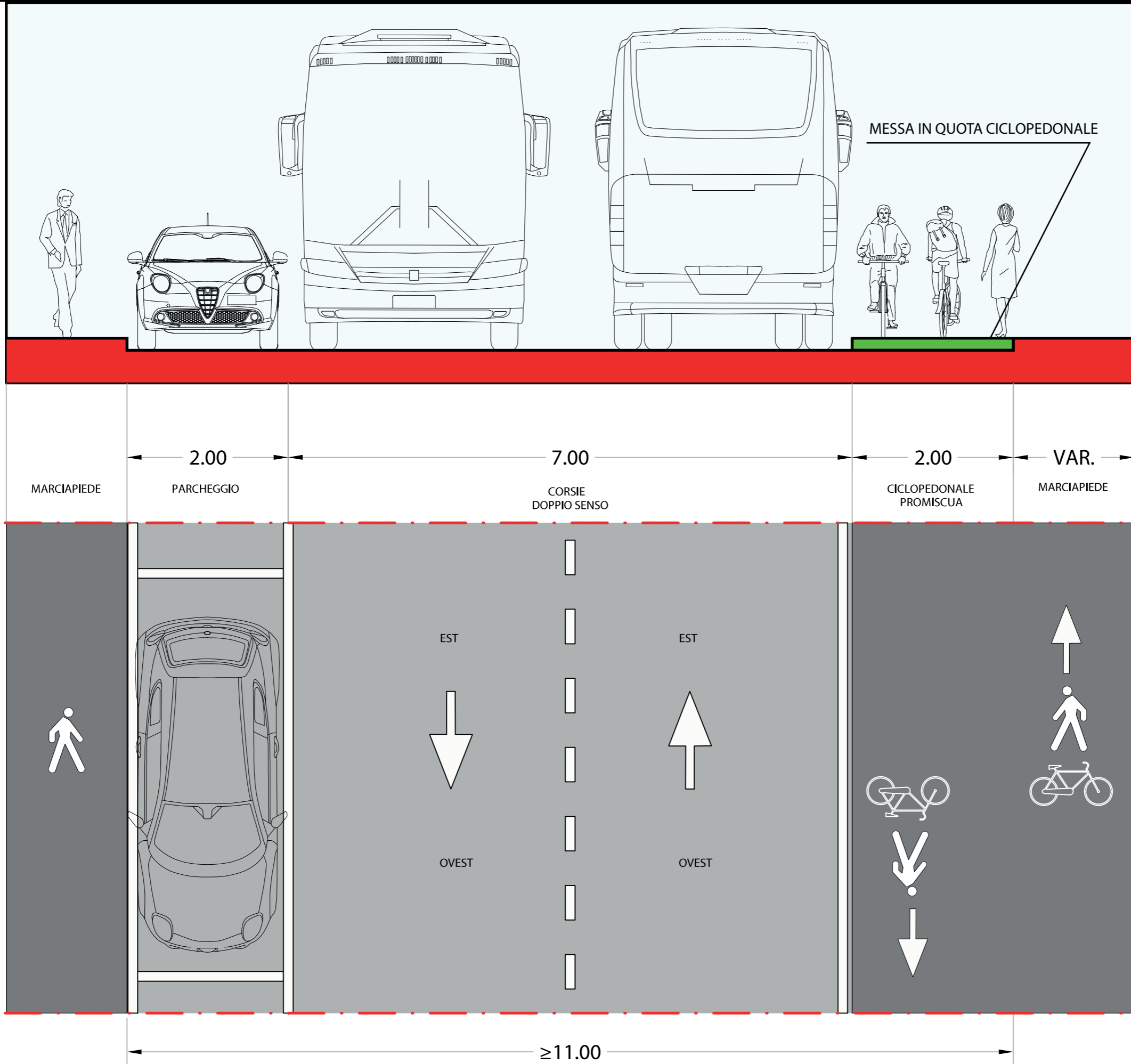

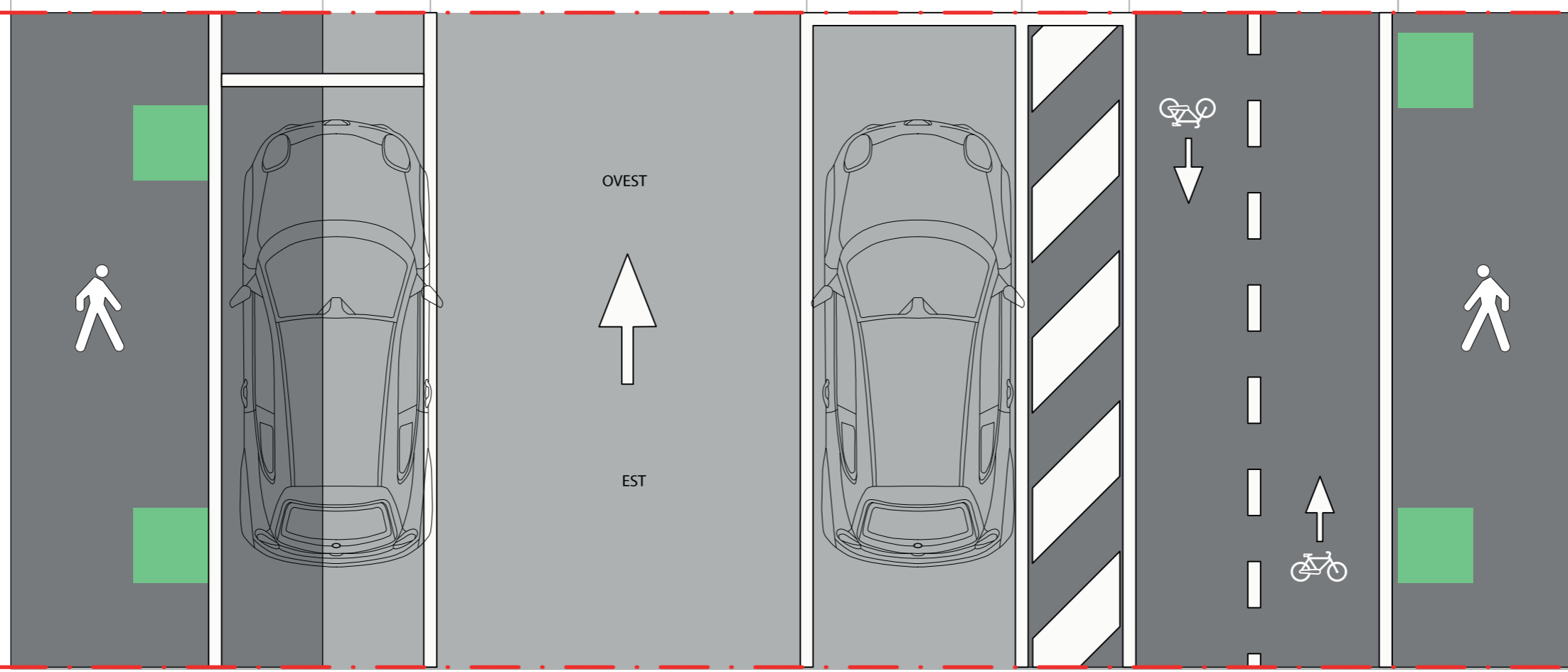
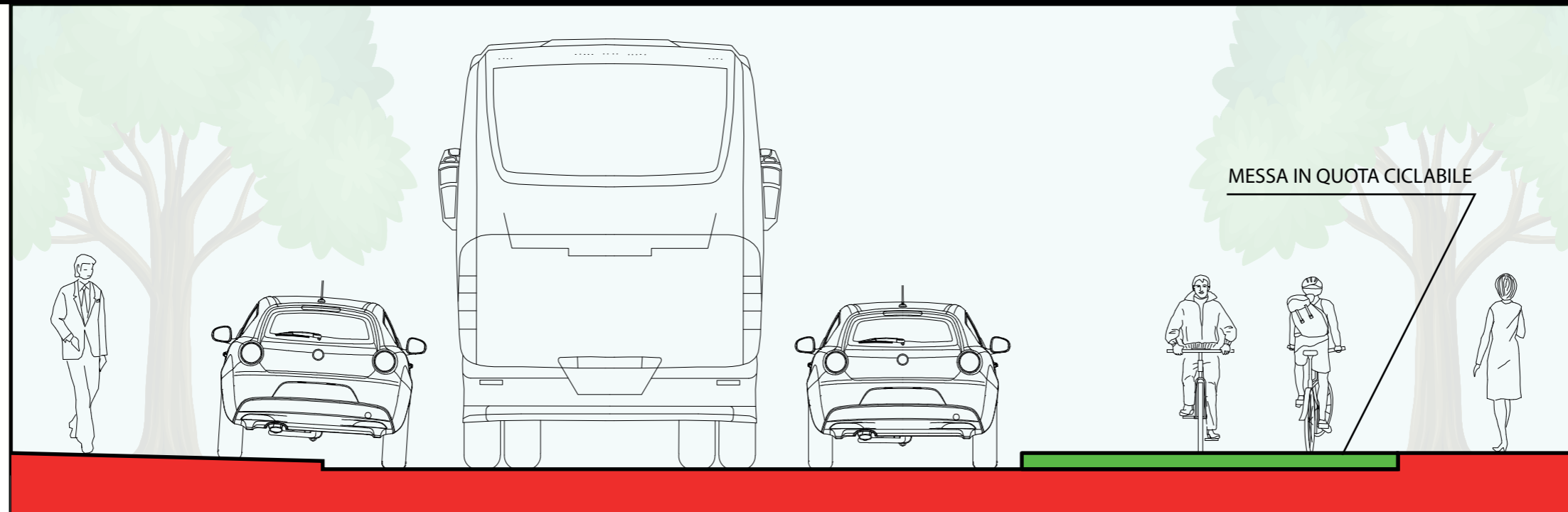

13.90 - 14.60



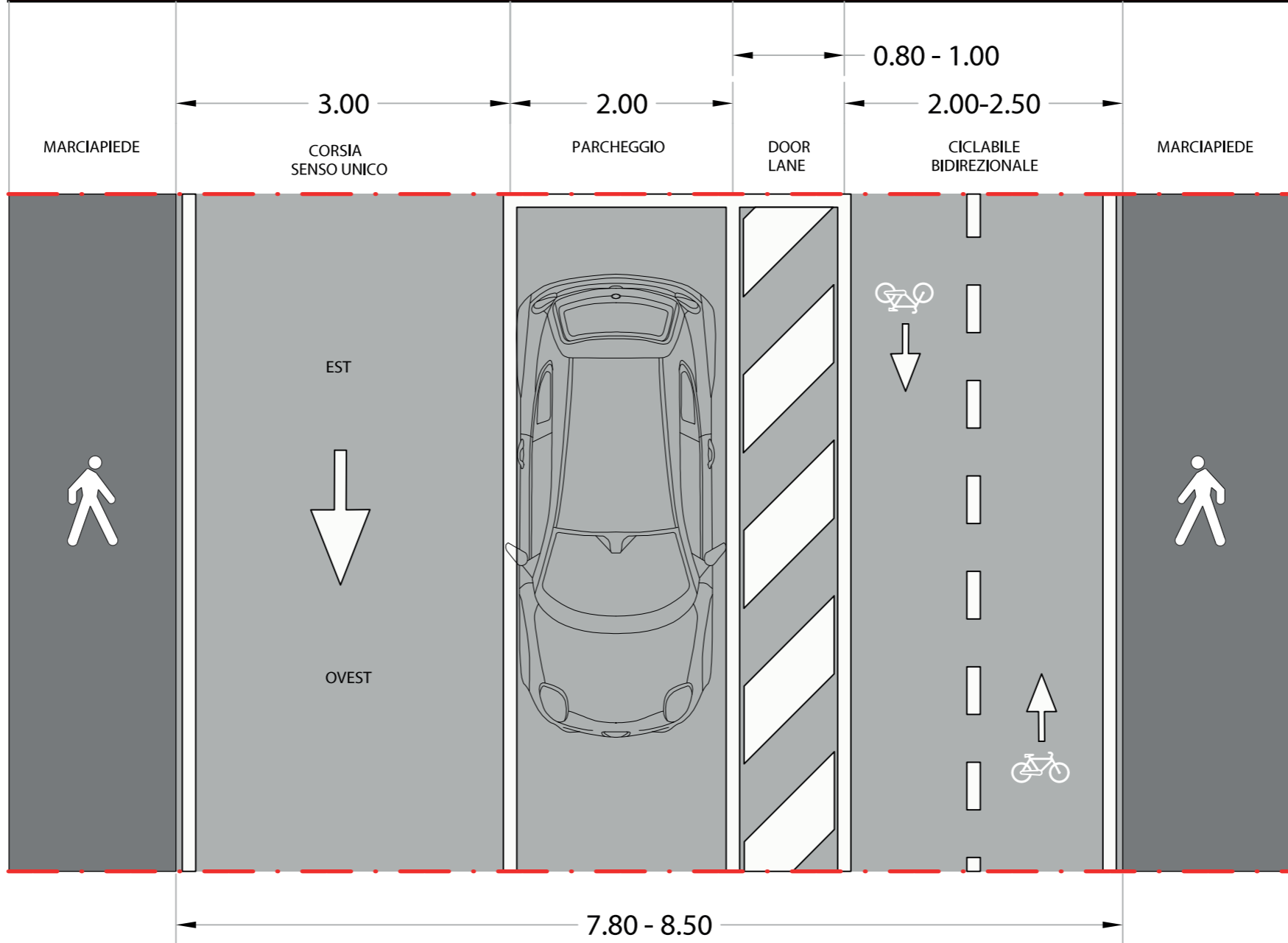
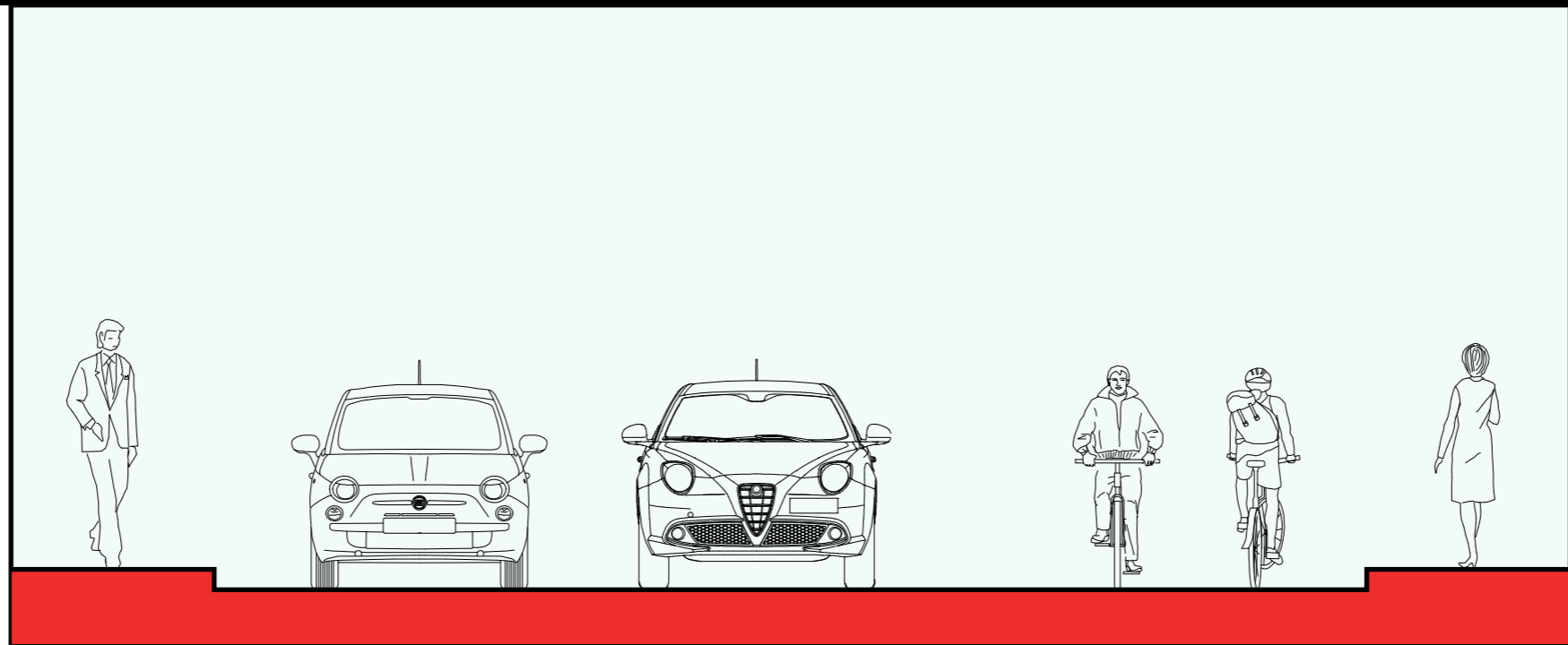

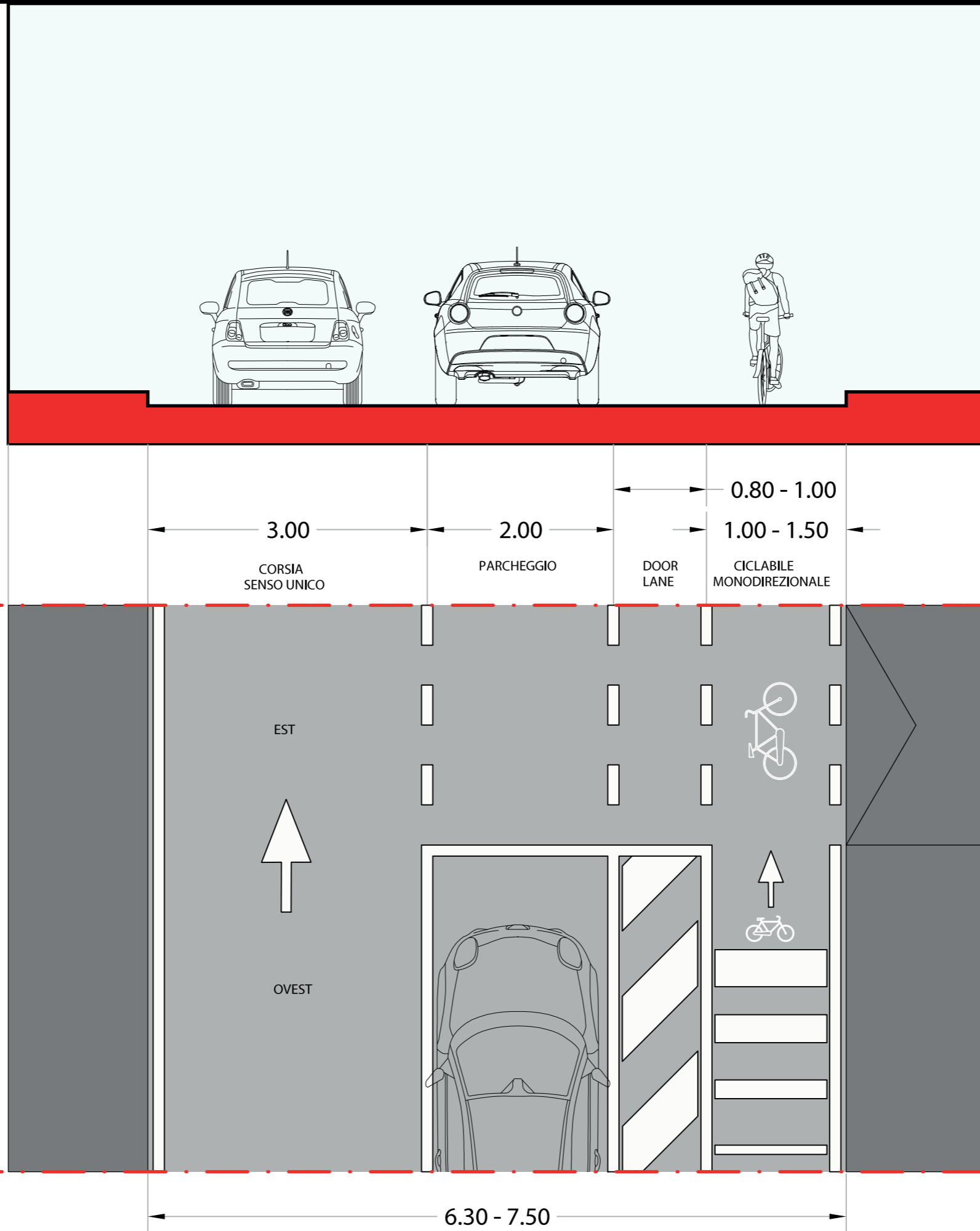

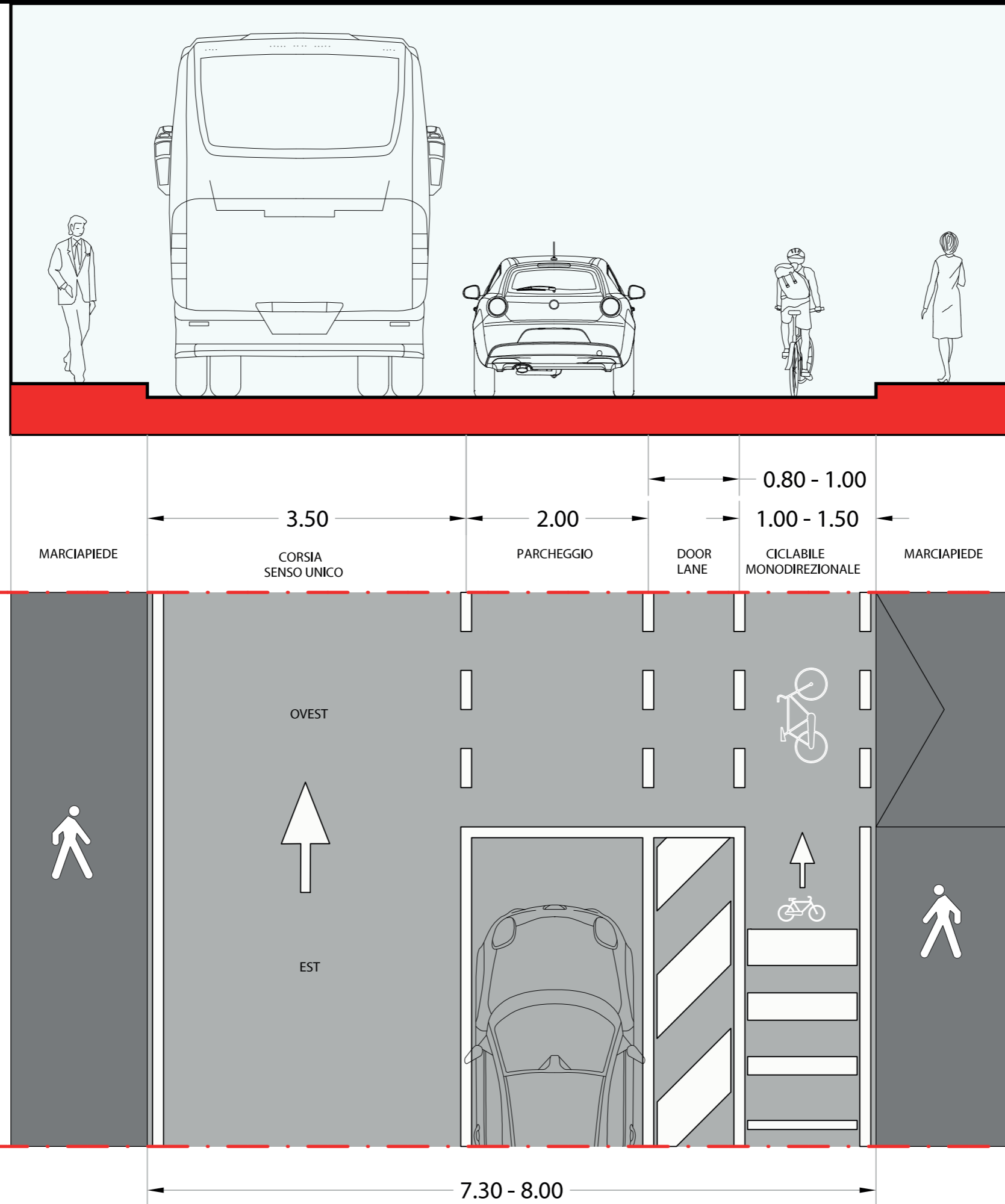

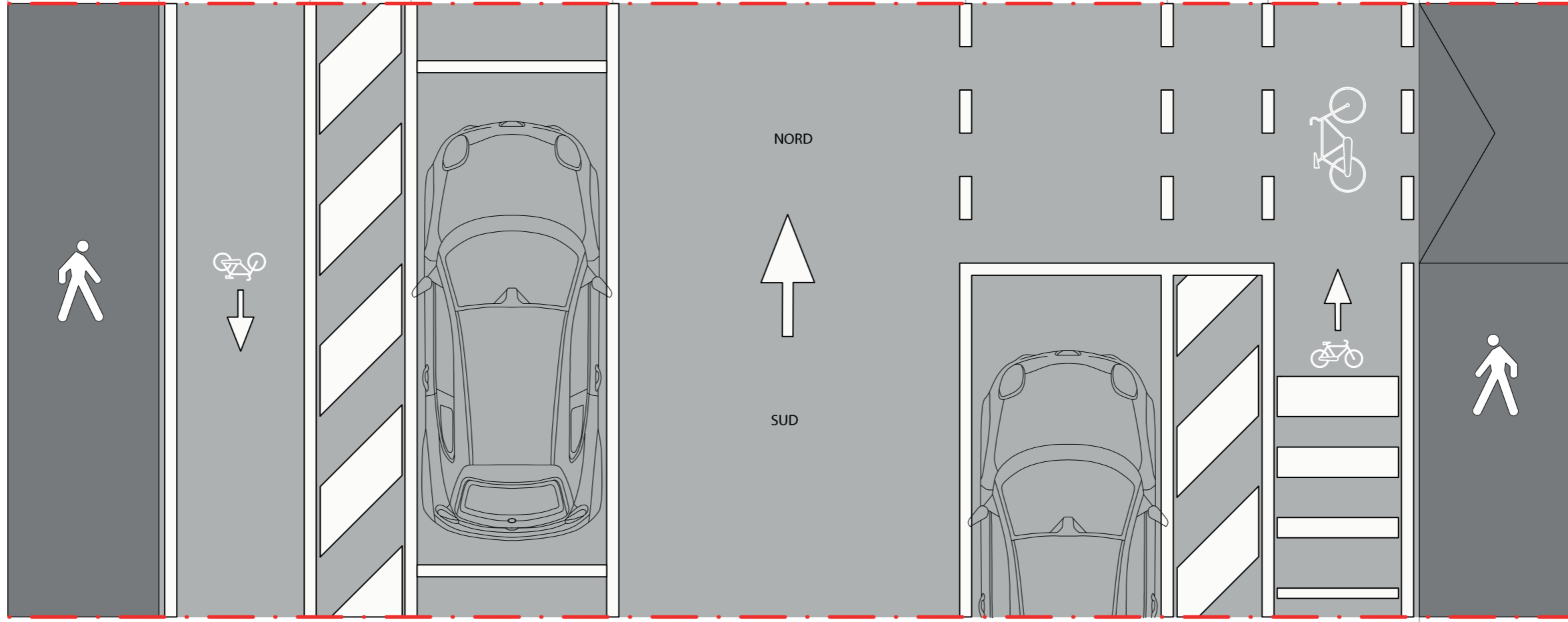
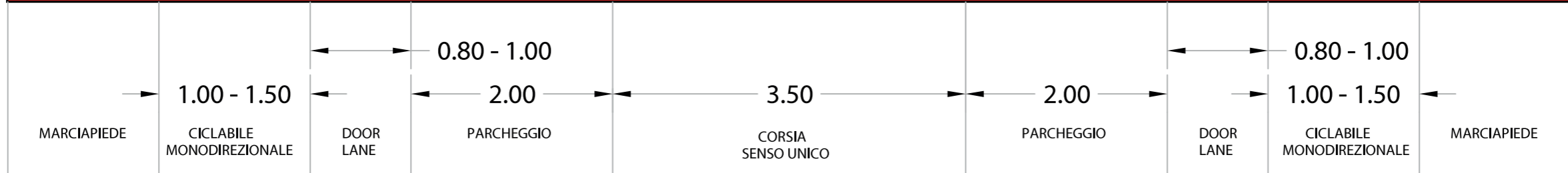
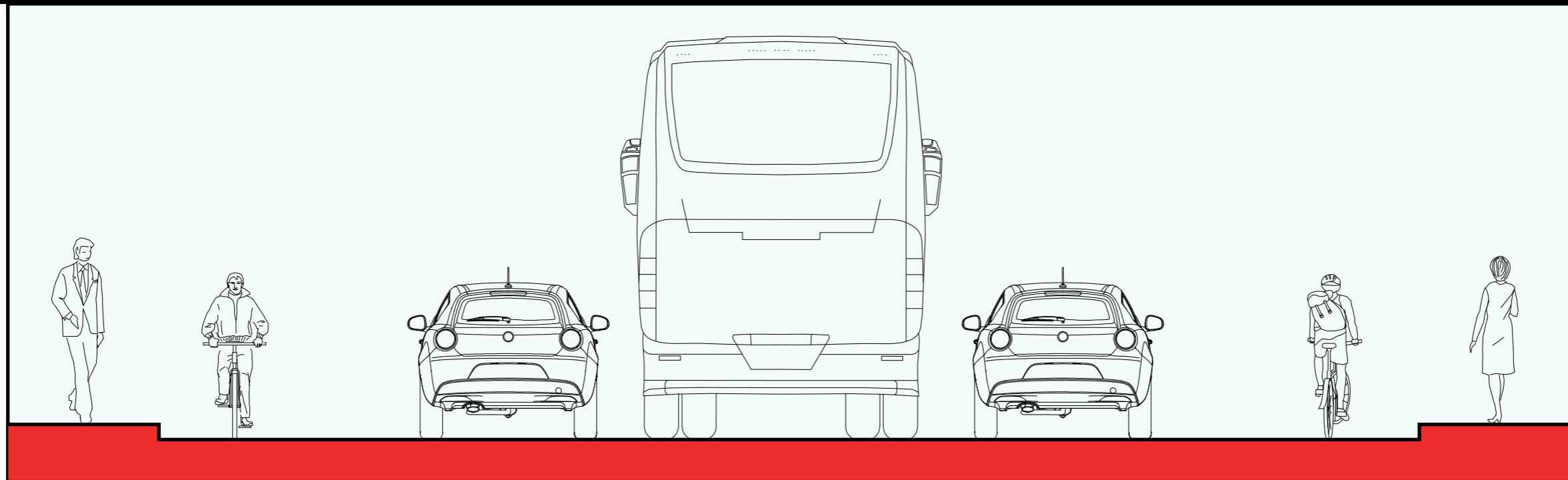

11.10 - 12.50

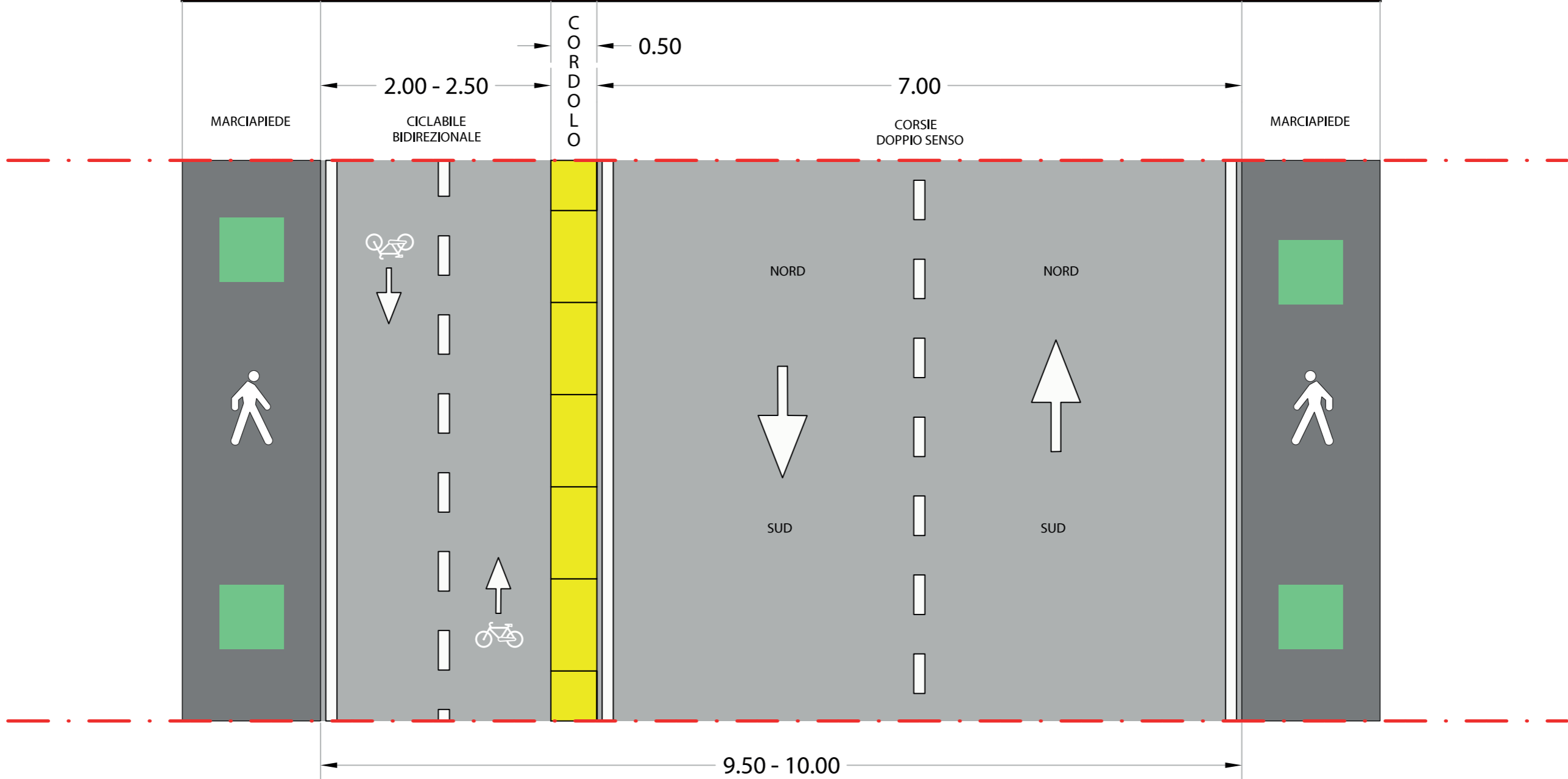
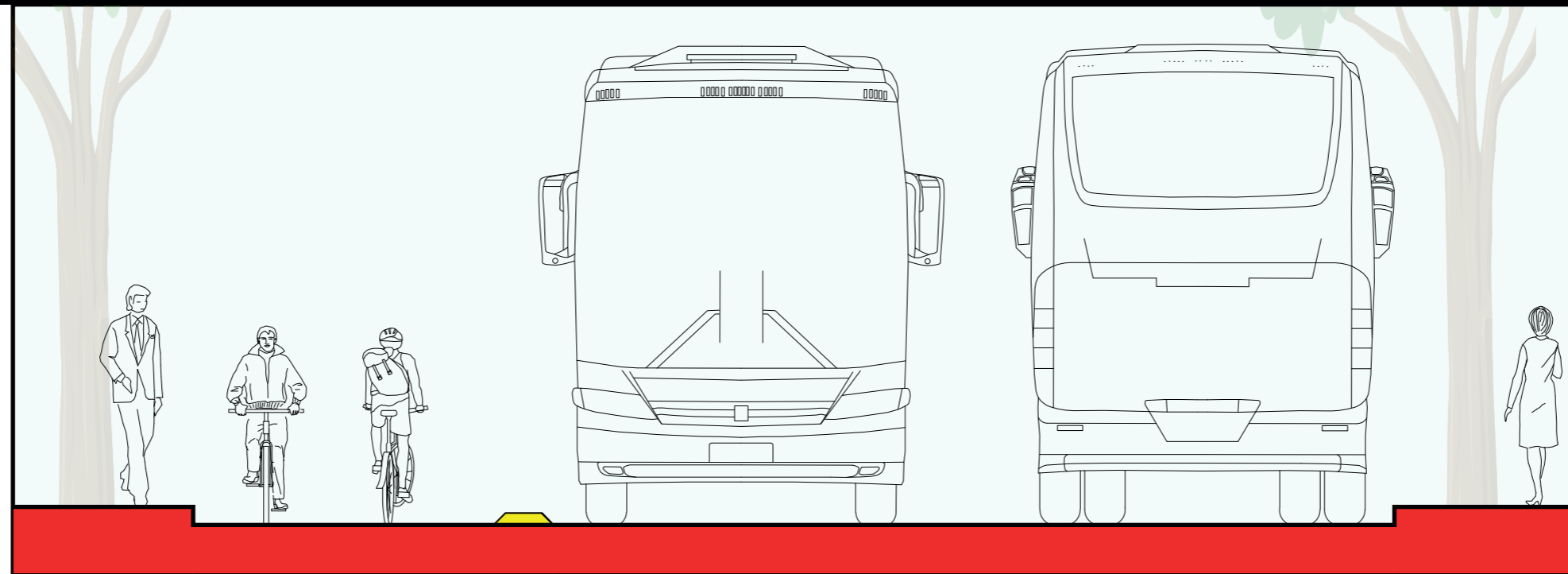

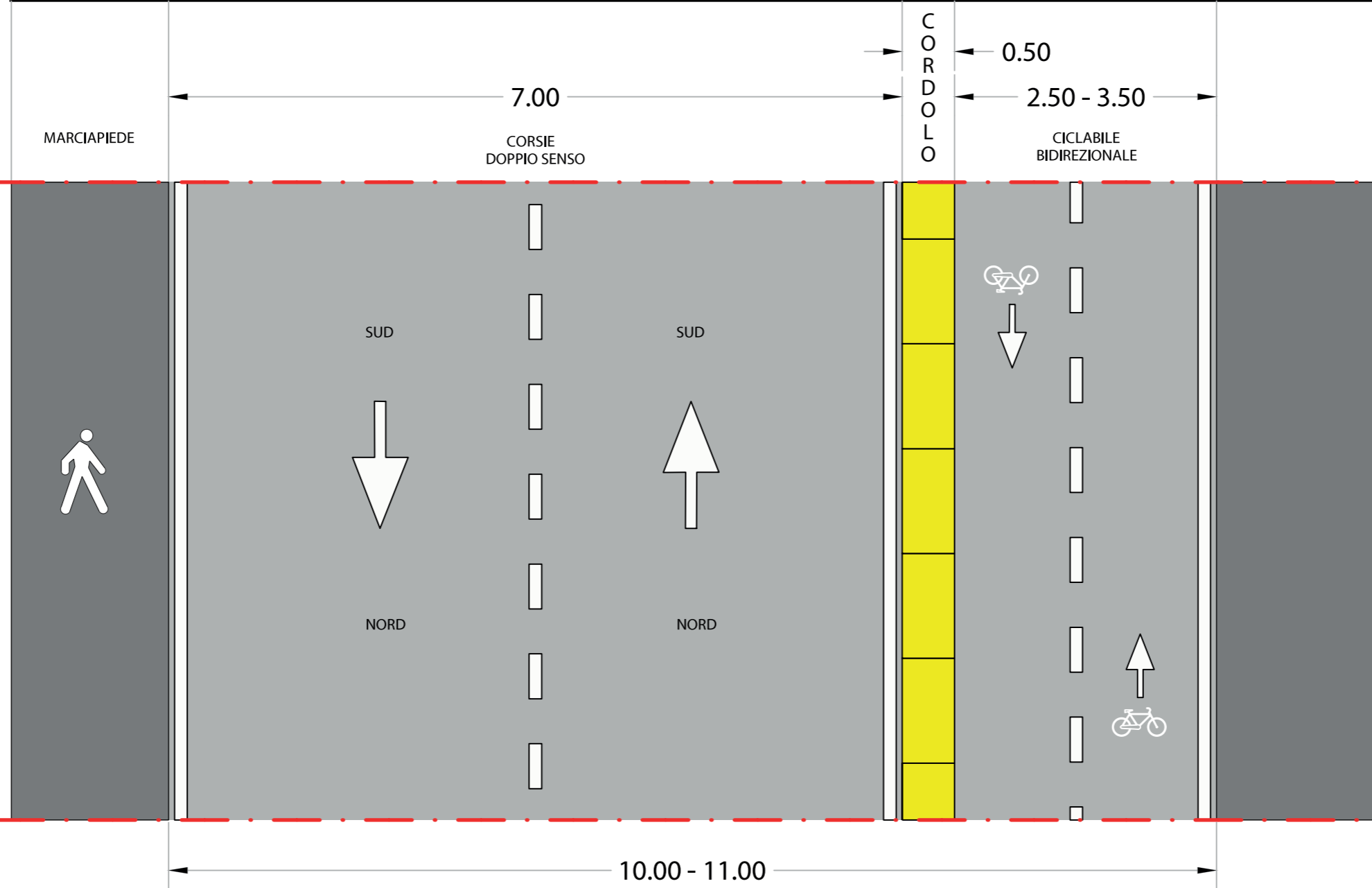
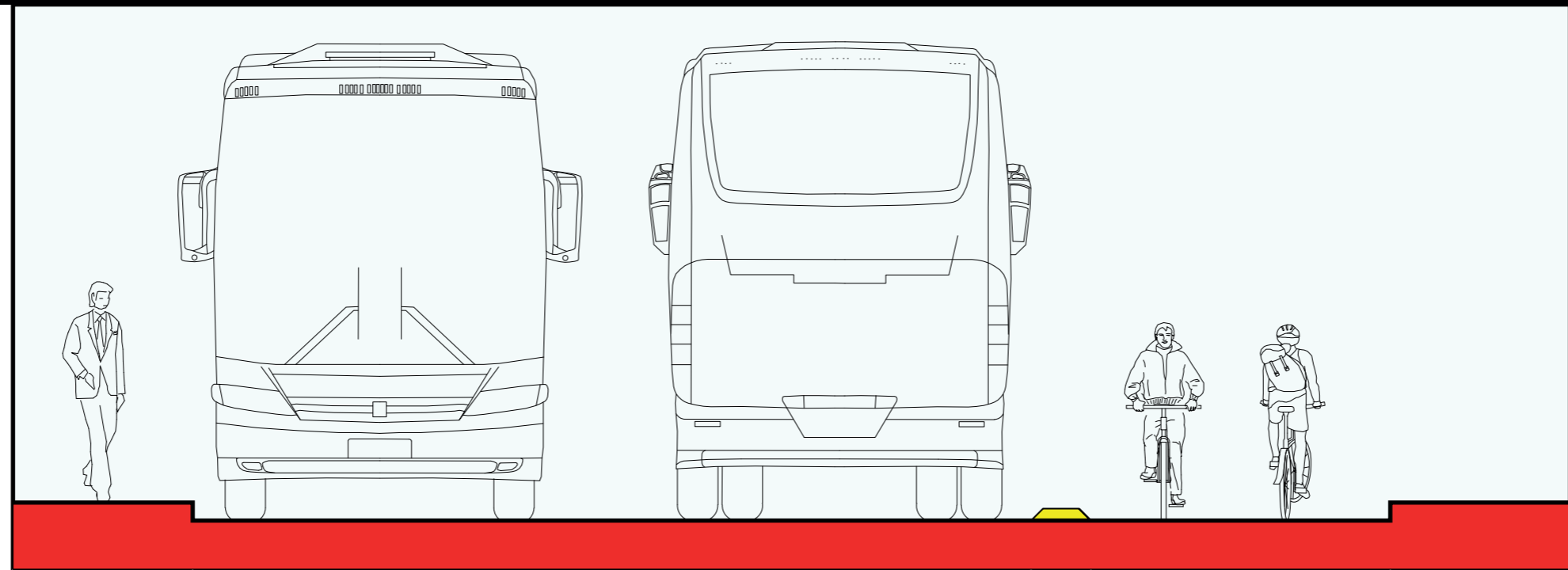

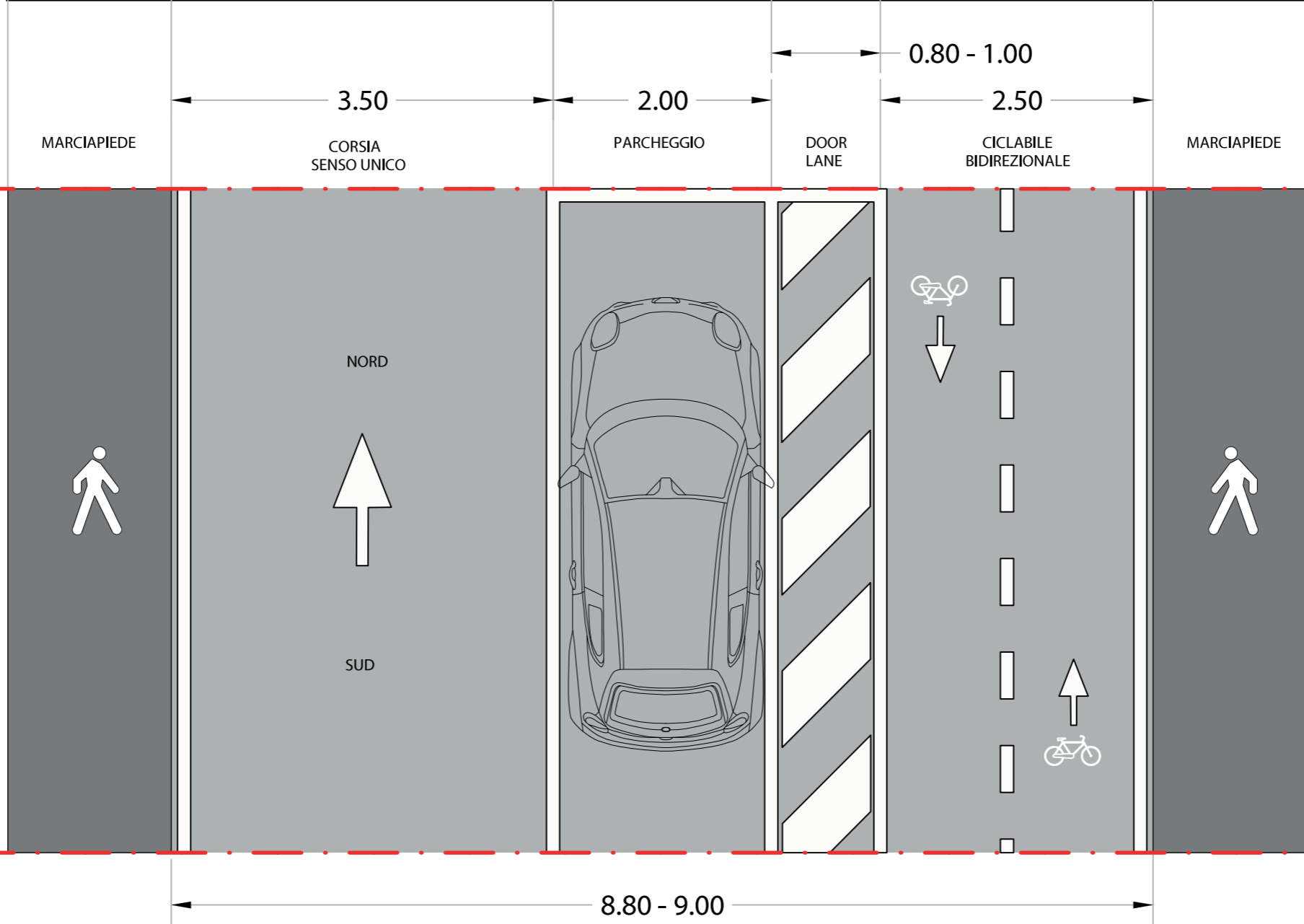
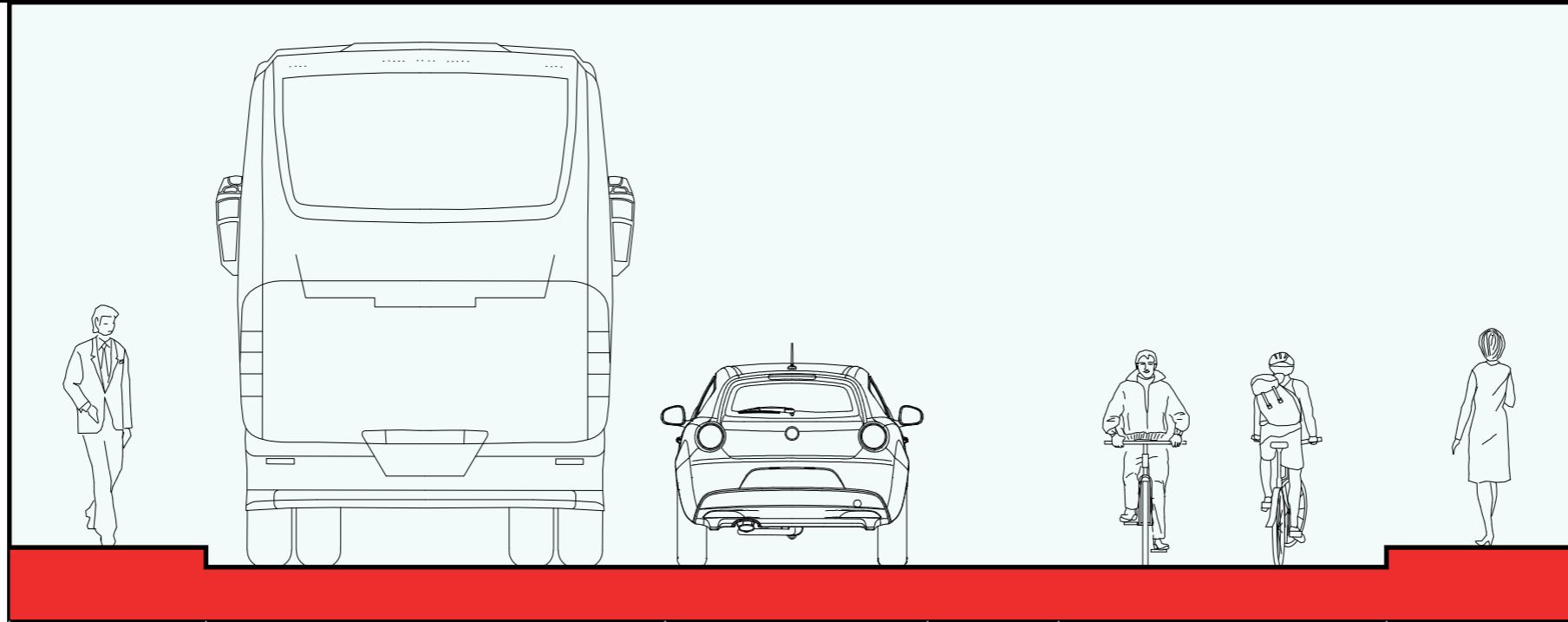

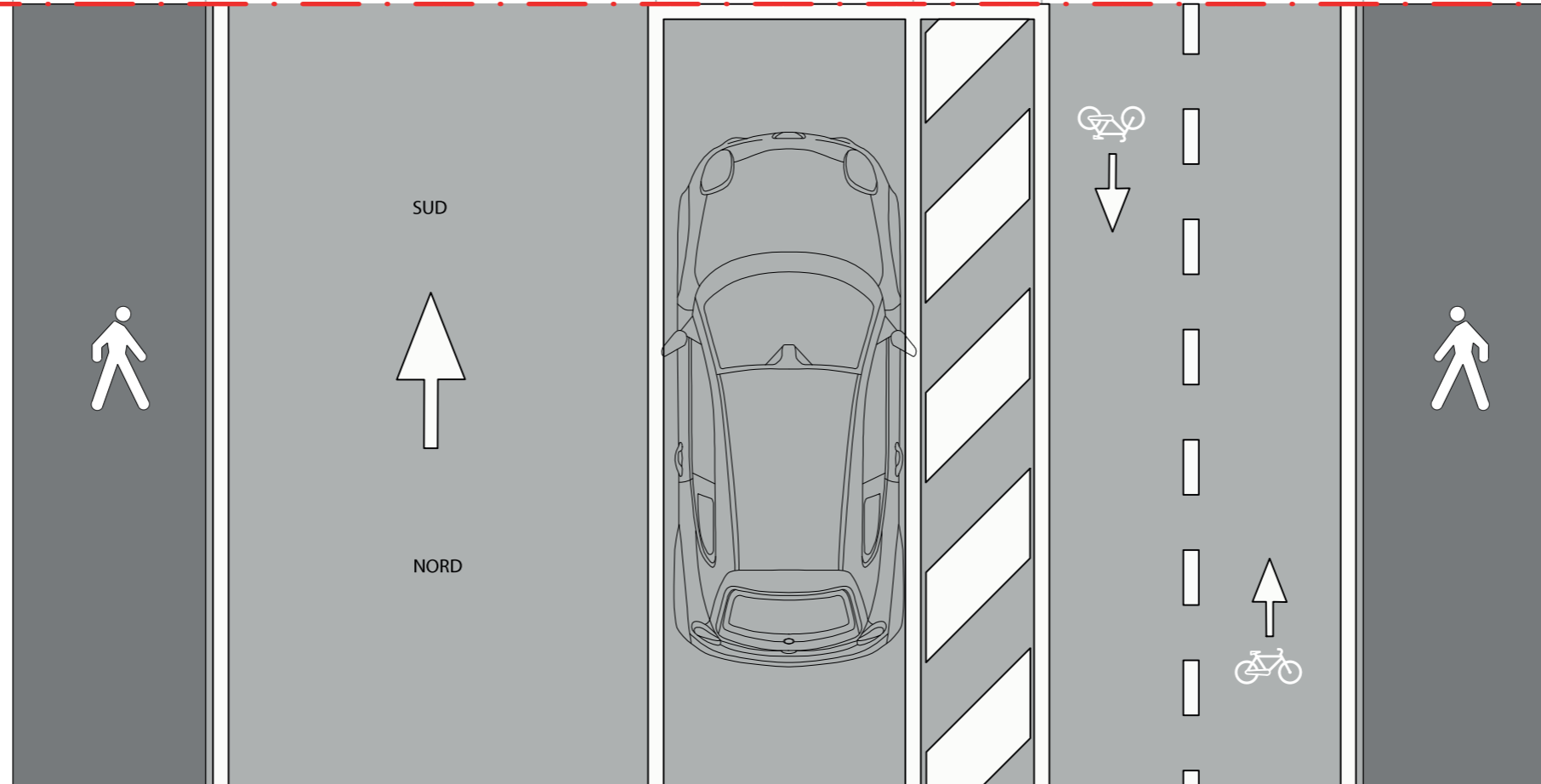
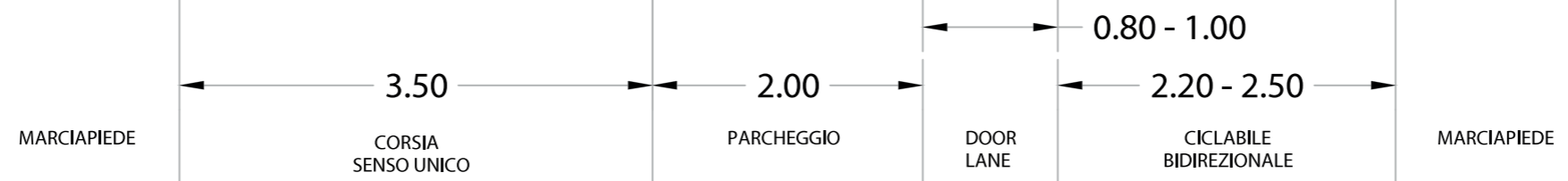
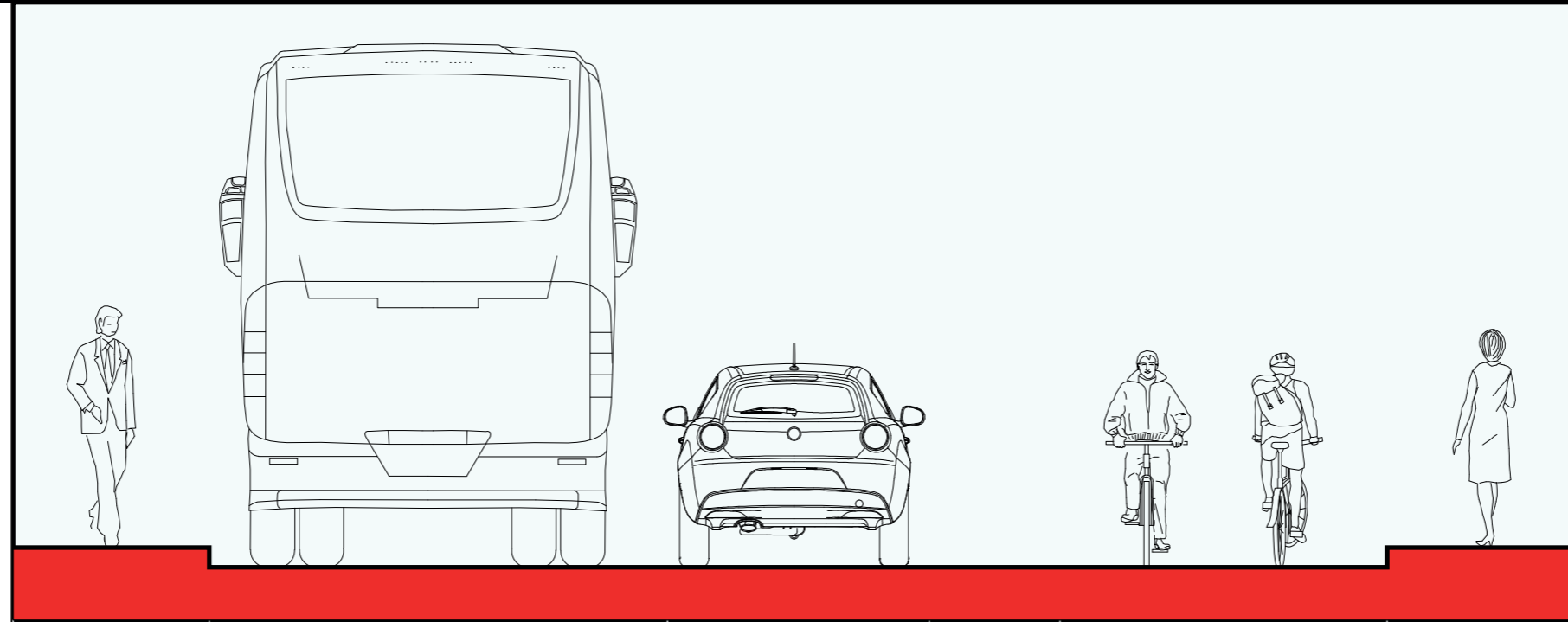

8.50 - 9.00



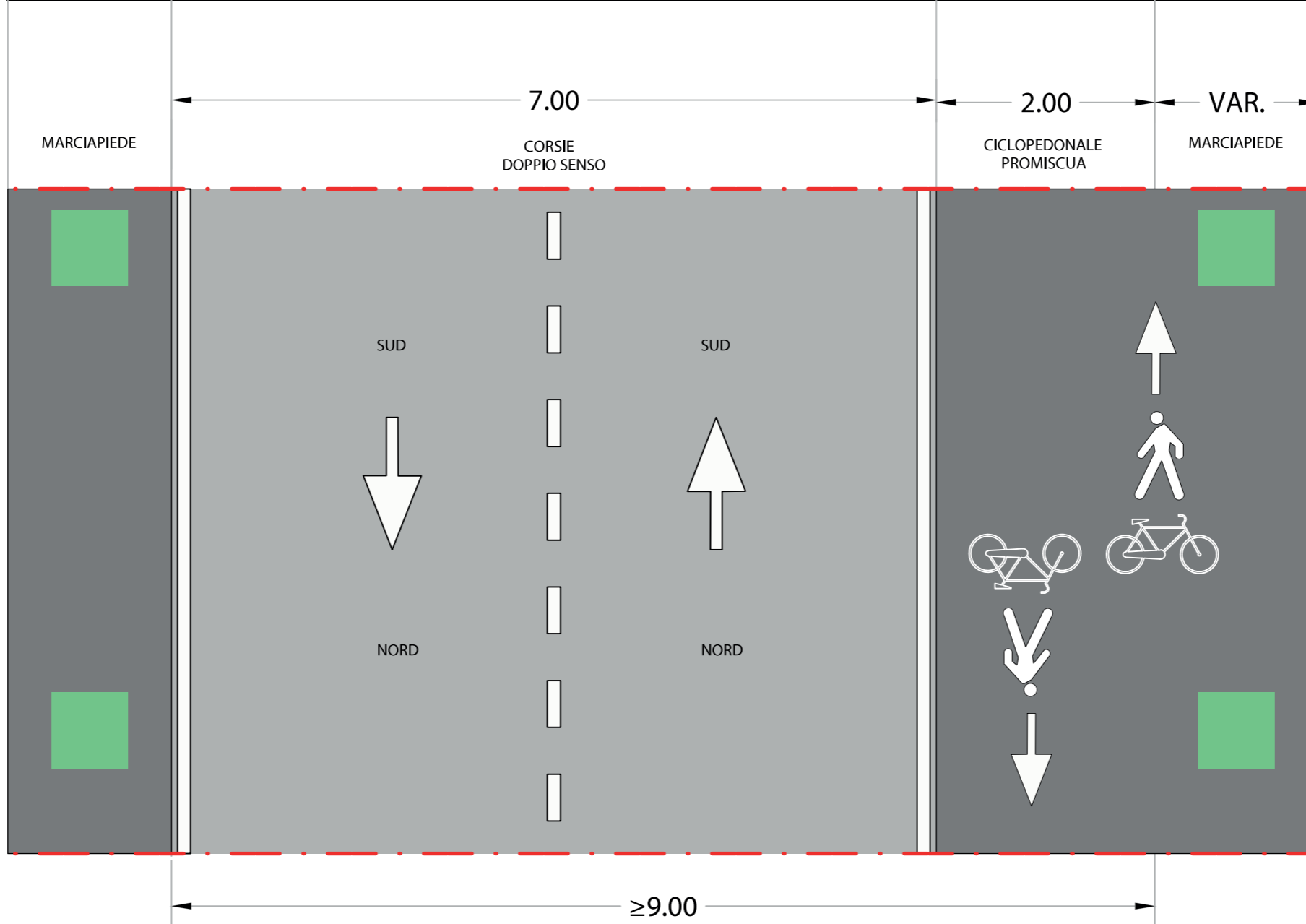
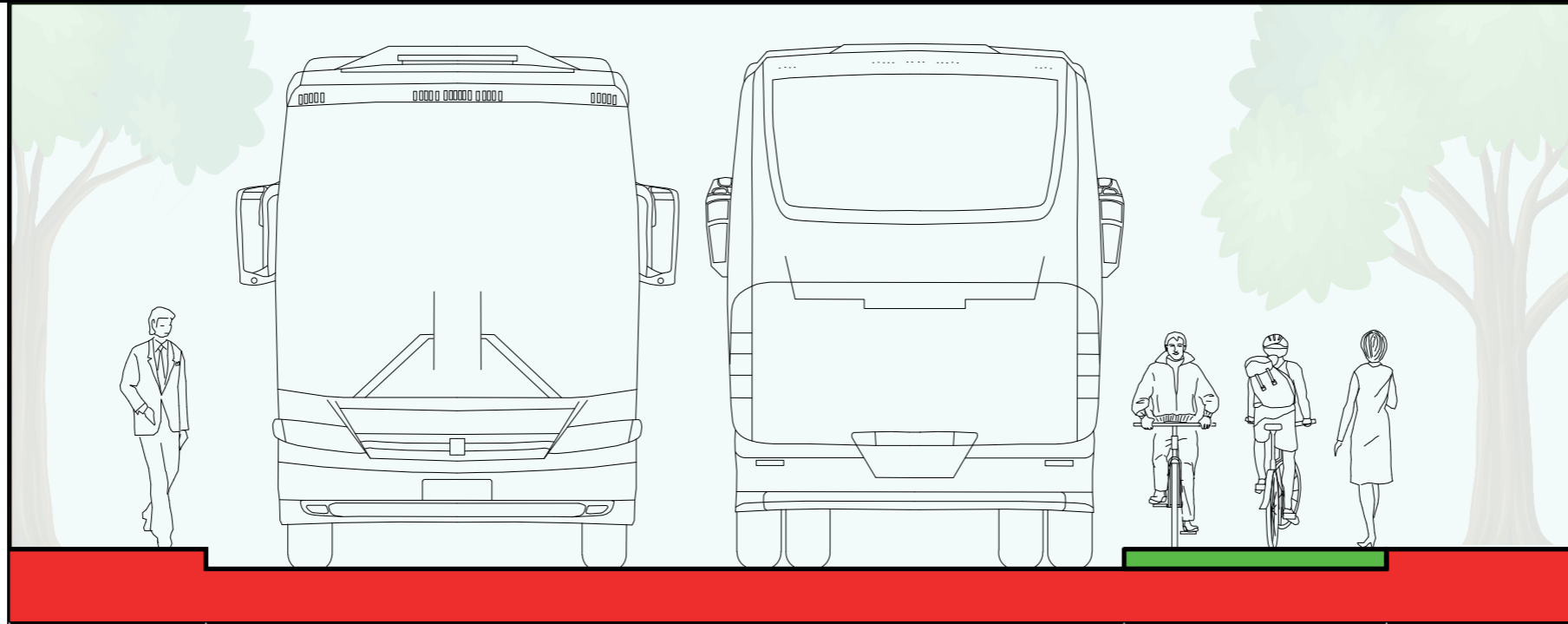

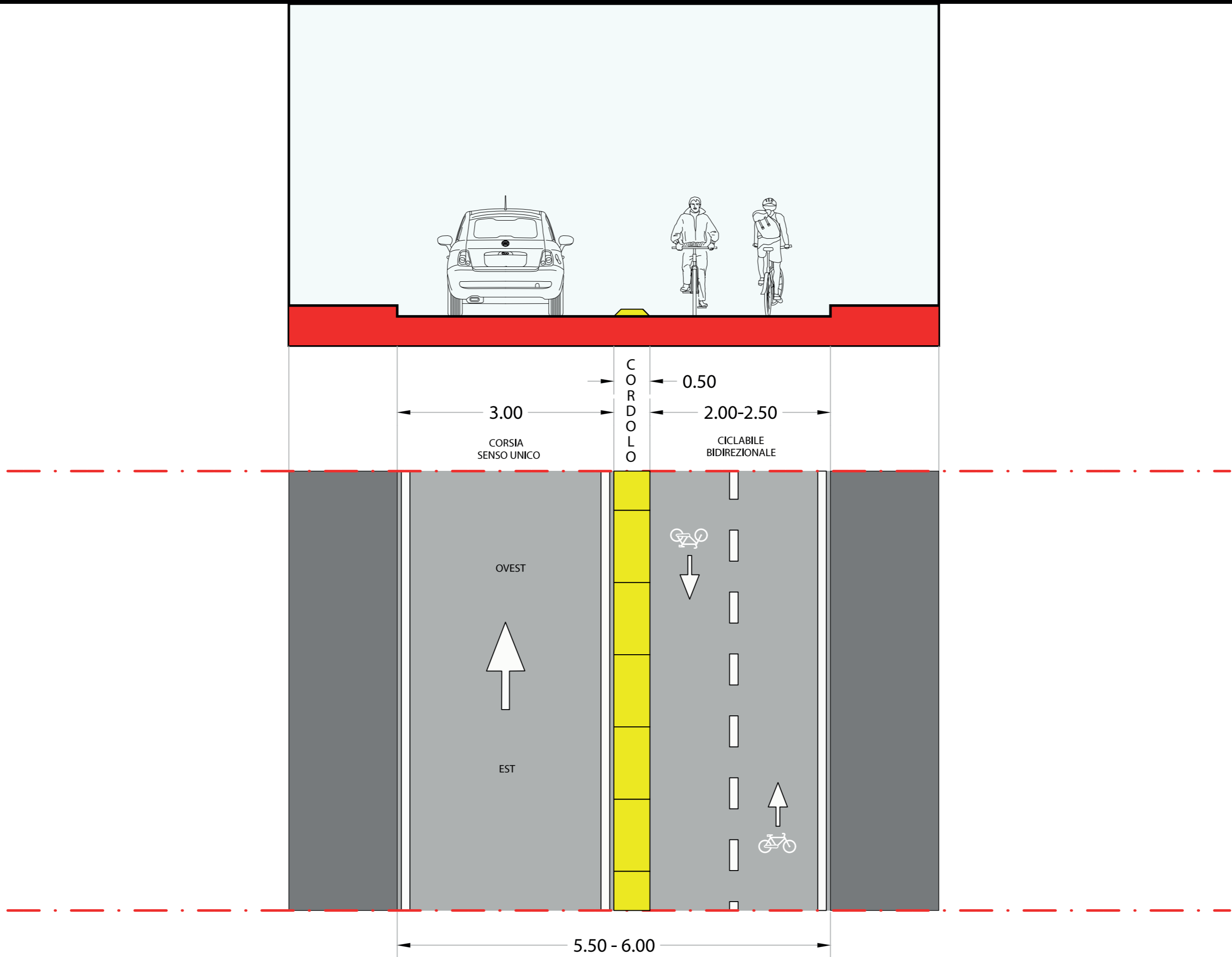

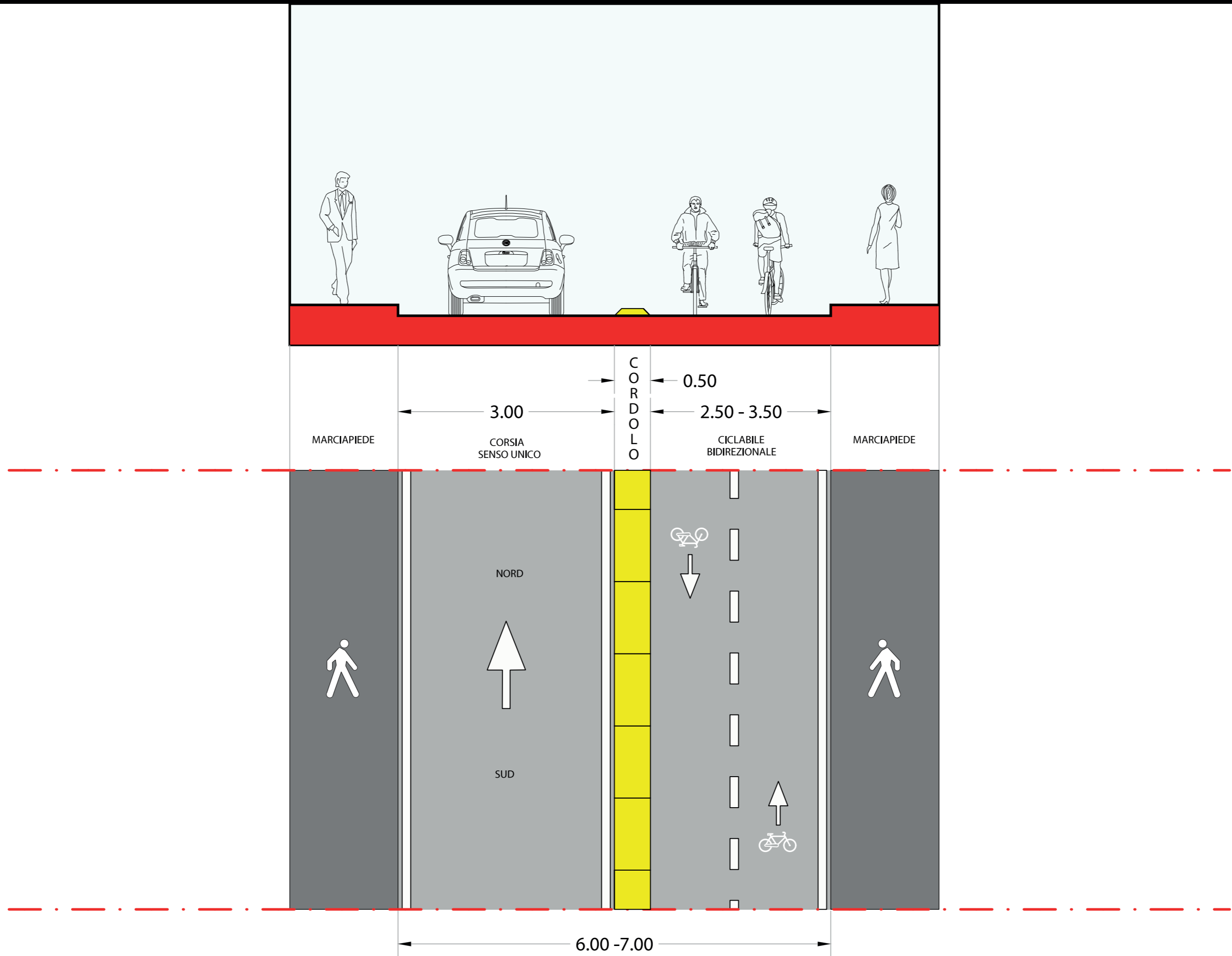

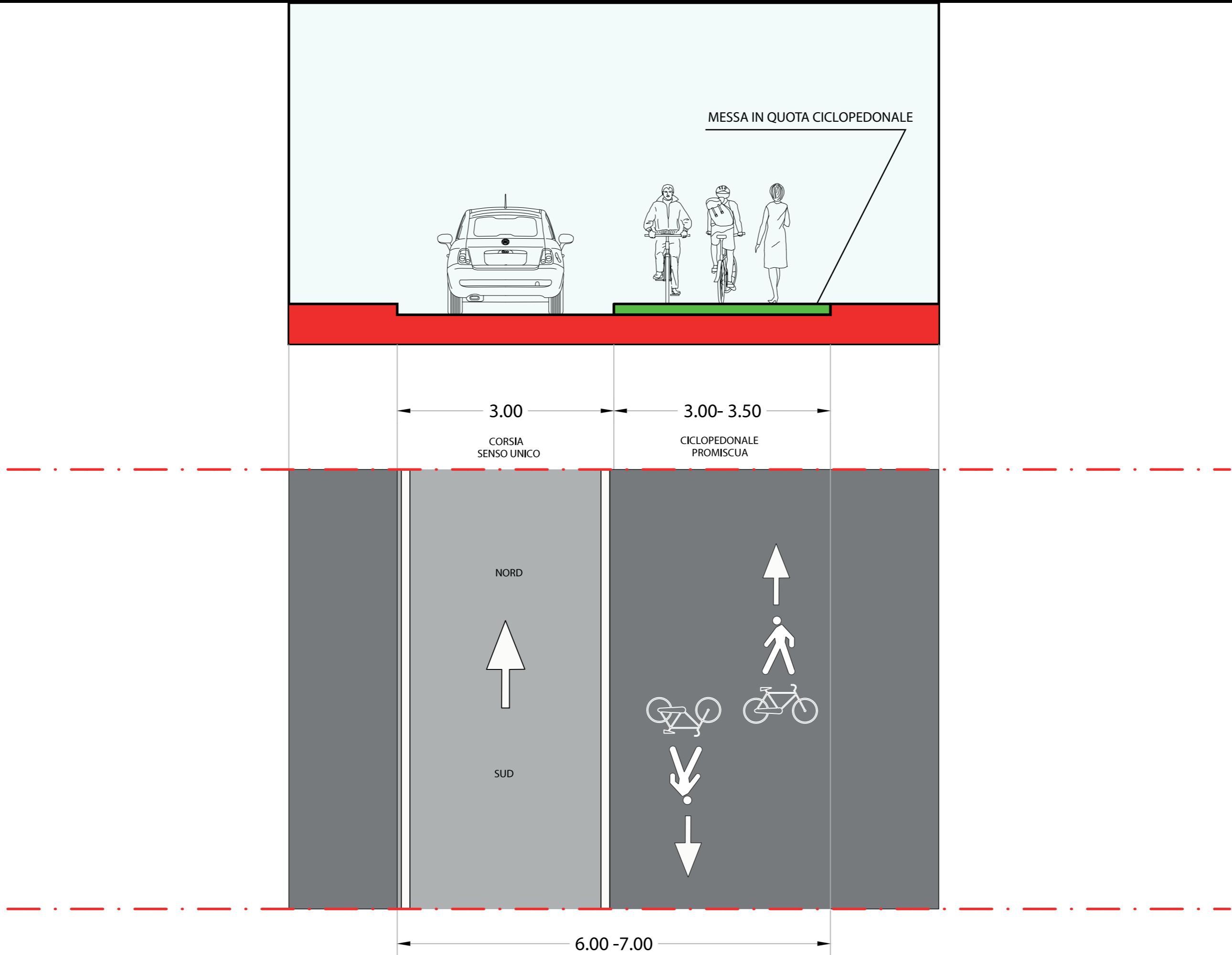

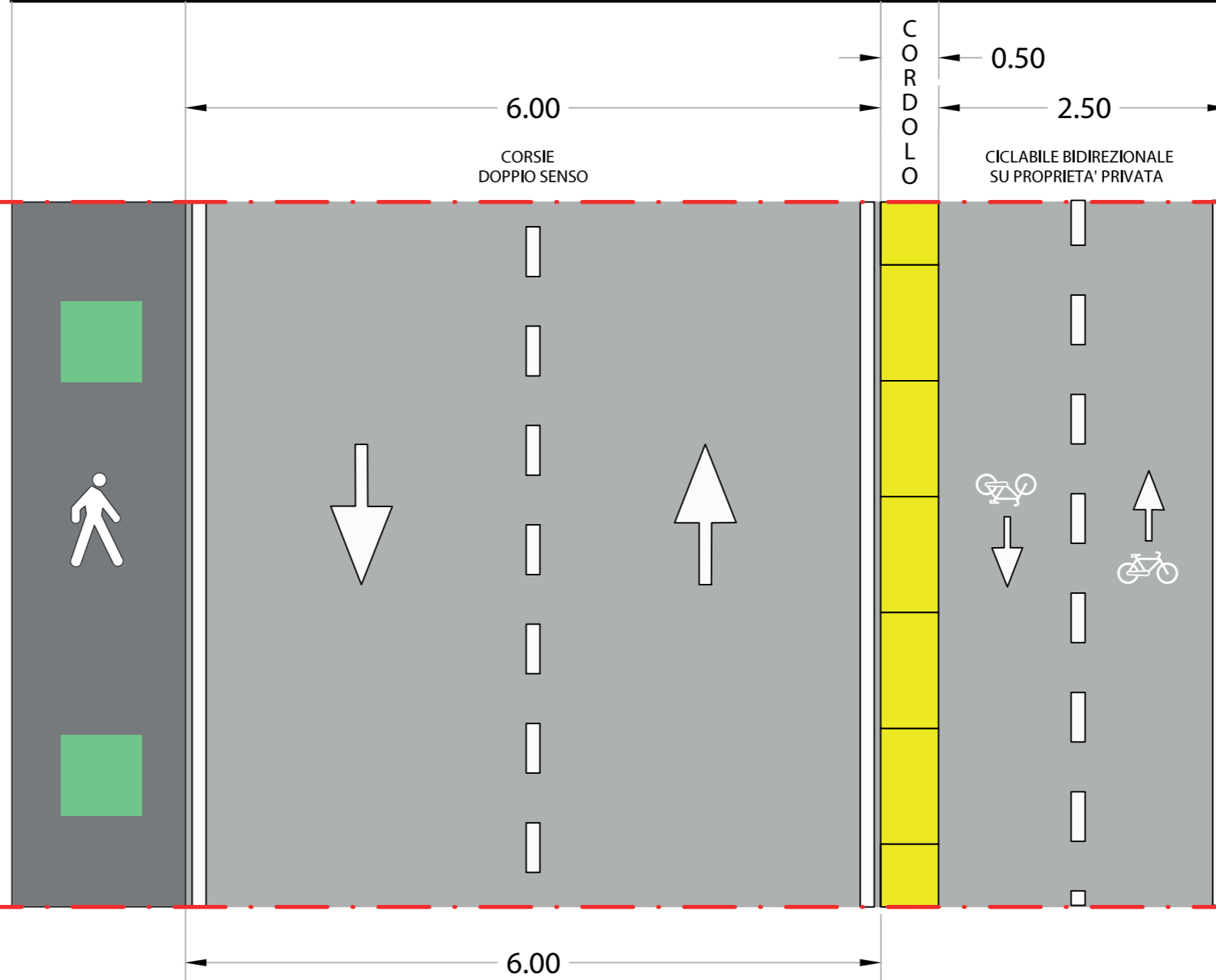

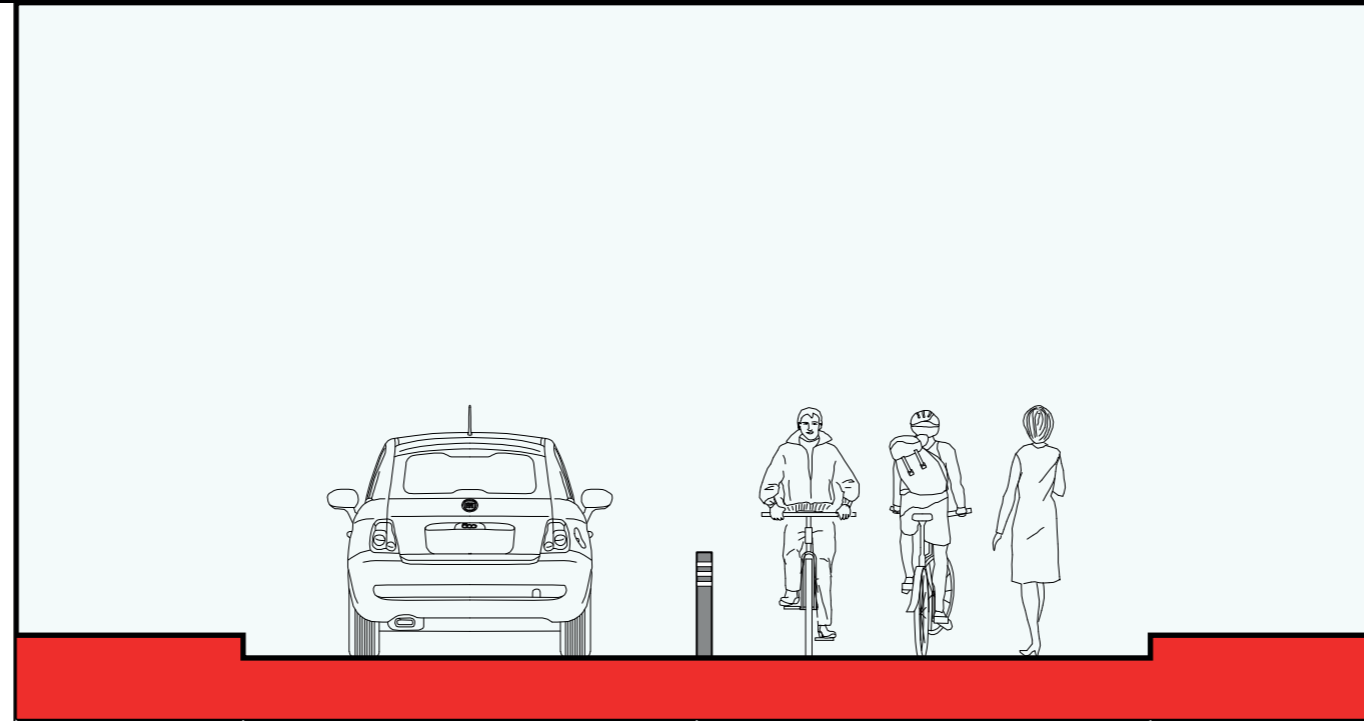

3.00  
CORSIA  
SENSO UNICO

3.50  
CICLOPEDONALE  
PROMISCUA

